



Doppler Current Profiler Sensor DCPS 5400 / 5402 / 5403

Preliminary Edition	26 October 2014	
1 st Edition	10 July 2015	
2 nd Edition	18 December 2015	
3 rd Edition	13 July 2018	New Firmware release from image 8.3.6
4 th Edition	25 May 2019	New Acoustic Wave Software, new Cell States description. New structure and reorganization of chapters, from image 20.4.26
5 th Edition	20 July 2019	Updates and added chapter 9 to 11 from image 20.4.33

Contact information:

Aanderaa Data Instrument AS
PO BOX 103, Midttun
5843 Bergen, NORWAY

Visiting address:
Sandalsringen 5b
5843 Bergen, Norway

TEL: +47 55 604800
FAX: +47 55 604801

EMAIL: aanderaa.support@xylem.com

WEB: <http://www.aanderaa.com>

Table of Contents

Introduction.....	8
Purpose and scope.....	8
CHAPTER 1 Short description and specifications of the DCPS	11
1.1 Description	11
1.2 Sensor Dimension	13
1.3 Sensor pin configuration and data output.....	13
1.3.1 Sensor pin configuration 5400/5402/5403 with RS-232 and AiCaP communication	13
1.3.2 Sensor pin configuration 5400R/5402R/5403R with RS-422 communication	14
1.4 Sensor Connection	15
1.4.1 Configure sensor using RS-232 configuration cable	15
1.5 User accessible sensor properties	16
1.6 Passkey for write protection.....	16
1.7 Sensor Properties.....	17
1.7.1 Factory Configuration	18
1.7.2 Deployment Settings.....	20
1.7.3 System Configuration	23
1.7.4 User Maintenance.....	31
1.8 Manufacturing and Quality Control.....	32
CHAPTER 2 Stand-alone sensor configuration using AADI Real-Time Collector.....	33
2.1 Establishing a new connection.....	33
2.1.1 Establish connection.....	35
2.1.2 Control Panel.....	36
2.2 Changing Values	37
2.3 Deployment Settings	39
2.3.1 Common Settings	40
2.3.2 Site Info	40
2.3.3 Orientation.....	40
2.3.4 Fixed Settings.....	41
2.3.5 Calculations.....	42
2.4 System Configuration	43
2.4.1 Common settings.....	45
2.4.2 Terminal Protocol settings	45
2.4.3 Orientation settings.....	46
2.4.4 Measurement settings	46
2.4.5 Surface settings – Configuration.....	48
2.4.6 Column 1	48
2.4.7 Column 2.....	49
2.4.8 Column 3.....	50
2.4.9 Output enabling – Profile Parameters.....	51
2.4.10 User Specified settings – Profile Parameters	53
2.4.11 Output enabling – Sensor Parameters	55

- 2.4.12 Output enabling – System Parameters 56
- 2.4.13 Output enabling – Virtual Sensors 56
- 2.5 User Maintenance settings 57
 - 2.5.1 Mandatory 57
 - 2.5.2 Site Info 58
 - 2.5.3 Serial Port 58
 - 2.5.4 Terminal Protocol 59
 - 2.5.5 Profiler Dependencies 59
- CHAPTER 3 Configuration via SmartGuard or SeaGuardII Datalogger 60
 - 3.1 Introduction 60
 - 3.2 Installation of the DCPS on SeaGuardII 60
 - 3.3 Configuration with Real-Time collector 61
 - 3.3.1 Connected via SeaGuardII 61
 - 3.3.2 Connected via SmartGuard 61
 - 3.3.3 Establish connection 61
 - 3.3.4 Control Panel 63
 - 3.4 Changing Values 66
 - 3.5 Deployment settings 68
 - 3.5.1 Site Info 70
 - 3.5.2 Orientation 70
 - 3.5.3 Fixed Settings 71
 - 3.5.4 Calculations 71
 - 3.5.5 Input Parameter Pressure 72
 - 3.5.6 Input Parameter Air Pressure 72
 - 3.5.7 Input Parameter Temperature 72
 - 3.5.8 Input Parameter Conductivity 73
 - 3.5.9 Input Parameter Heading 73
 - 3.6 System Configuration 74
 - 3.6.1 Orientation 77
 - 3.6.2 Wave Measurement 77
 - 3.6.3 Current Profile Measurement 78
 - 3.6.4 Surface 79
 - 3.6.5 Column 1 80
 - 3.6.6 Column 2 81
 - 3.6.7 Column 3 82
 - 3.6.8 Column 4 82
 - 3.6.9 Output/Storage Wave Parameters 83
 - 3.6.10 Output/Storage Profile Parameters 84
 - 3.6.11 User Specified – Profile Parameters 86
 - 3.6.12 Output/Storage - Sensor Parameters 88
 - 3.6.13 Output/Storage System Parameters 89
 - 3.6.14 Output/Storage Virtual Sensor 89
 - 3.7 User Maintenance 90
 - 3.7.1 Mandatory 91

- 3.7.2 Site Info 91
- 3.7.3 Serial Port 91
- 3.7.4 Licensed Options 92
- 3.7.5 Wave Measurement 92
- 3.7.6 Profiler Dependencies 93
- 3.8 Sensor software versions for use together with SeaGuardII / SmartGuard 93
- CHAPTER 4 Logging data via AADI Real-Time Collector 94
 - 4.1 Logging data on PC 94
 - 4.1.1 Enabling file output 94
 - 4.1.2 Starting the sensor and logging to file 96
 - 4.2 Viewing incoming data in real-time 97
- CHAPTER 5 Stand-alone Sensor configuration using Smart Sensor Terminal 99
 - 5.1 Sensor versions and interface 99
 - 5.2 RS-422 transmission line explained 99
 - 5.3 Communication setup 100
 - 5.4 Sensor startup 100
 - 5.5 Description of protocol 101
 - 5.5.1 Save and Reset 102
 - 5.5.2 Available commands 103
 - 5.5.3 The Get command 104
 - 5.5.4 The Set command 104
 - 5.5.5 XML commands 105
 - 5.5.6 Examples – How to configure sensor in Smart Sensor Terminal mode 105
 - 5.6 Help command output 107
 - 5.7 Output parameters 112
 - 5.7.1 Parameters outside profile data 112
 - 5.7.2 Record State 114
 - 5.7.3 Cell Parameters 116
 - 5.7.4 Cell States 121
- CHAPTER 6 Software versions and Stand-alone usage 124
 - 6.1 Interval and Polled pingrate settings on software version below 8.1.27 124
 - 6.2 Interval and Polled Pingrate from software version 8.1.27 124
 - 6.3 Enabling old input on software versions from 8.1.34 124
- CHAPTER 7 Electro Magnetic Compatibility and Cables 125
 - 7.1 EMC Filter and Protection 125
 - 7.1.1 Underwater/Buoy systems 125
 - 7.1.2 Cable to land systems 125
 - 7.2 EMC Testing 126
 - 7.3 Cables 126
 - 7.4 Power – Voltage range 126
- CHAPTER 8 Acoustic Wave 127

- 8.1 General information 127
- 8.2 Parameter list 127
- 8.3 Parameter calculation 127
- 8.4 Other wave descriptions 129
- CHAPTER 9 Other details 130
 - 9.1 Compass heading 0° reference direction 130
 - 9.1.1 Transducer 1 is 0° reference 130
 - 9.1.2 Orientation/Steering pin as reference 131
 - 9.1.3 Transducer 1 as reference when upside-down 132
 - 9.1.4 Orientation/Steering pin as reference when upside-down 132
 - 9.2 Checking the compass 132
 - 9.3 Checking the tilt sensor 133
 - 9.4 Checking the acoustics 133
- CHAPTER 10 Maintenance 134
 - 10.1 Retrieval of the sensor 134
 - 10.2 Anti-fouling on transducer surface 134
 - 10.3 Factory service 135
 - 10.4 Example of Test & Specifications sheet and Certificates 136
- CHAPTER 11 Installation 141
 - 11.1 AADI Real-Time Collector connection with Windows 10 141
 - 11.2 Connecting Cables 143
 - 11.2.1 For AiCaP and RS-232 use 143
 - 11.2.2 For RS-422 use 145
 - 11.3 Mounting considerations 147
 - 11.4 Application examples 148

Introduction

Purpose and scope

This document is intended to give the reader knowledge of how to operate and maintain the Aanderaa Doppler Current Profiler Sensor 5400/5402/5403-series. These sensors are described in a single manual since the measurement principle and electronics are the same for all sensors. The DCPS 5400 is the shallow water version with a maximum depth rating of 300 meters. The DCPS 5402 is the intermediate water version with a maximum depth rating of 4500 meters, and the DCPS 5403 is the deep water version with a maximum depth rating of 6000 meters.

The sensor is designed to fit directly on the top-end plate of the Aanderaa SeaGuardII Platform using a sensor foot and can also be used together with the Aanderaa SmartGuard Datalogger. The sensor can also be used as a stand-alone sensor using RS-232. The R-version (5400R, 5402R, 5403R) has only RS-422 interface and is intended for stand-alone use with longer cables than with the RS-232 version.

Aanderaa Smart Sensors utilize common communication protocols at the RS-232 and RS-422 interface where the Smart Sensor Terminal protocol is a simple ASCII command string based protocol and the AADI Real Time is an XML based protocol. When used together with one of the Aanderaa Dataloggers the CAN bus based AiCaP communication protocol is used.

To configure and control the sensor we use sensor properties. A complete list of user accessible sensor properties is listed in chapter 1.7. The sensor properties are divided in 4 groups with different access levels. Some properties may be set on or off when others may contain different values. To change these setting you can either use AADI Real-Time Collector, described in CHAPTER 2 and CHAPTER 3 or terminal software like Terra Term, described in CHAPTER 5.

Note! Some settings are only visible when certain settings are enabled. Acoustic Wave is only available in AiCaP mode and when Wave software 5729 license key is installed and DCPS are used on a SeaGuardII with a Pressure, Tide or Wave and Tide Sensor connected to the same SeaGuardII. Surface cell and Surface reference is only recommended when DCPS is used on a SeaGuardII with a Pressure Sensor, Tide Sensor or Wave and Tide Sensor connected to the same SeaGuardII. However Surface Cell and Surface reference is also available without these sensors but are then using the fixed pressure setting and requires a precise depth setting and no tide variations. If there are any wave movement on the surface we recommend using Tide or Wave and Tide sensor and not Pressure Sensor. Pressure sensor is doing a point measurement and are not compensating for wave movements.

Document Overview

CHAPTER 1 is a short description of the sensor, sensor dimension, sensor connection and configuration properties.

CHAPTER 2 is an overview of how to configure a stand-alone DCPS when using AADI Real-Time Collector.

CHAPTER 3 is an overview of how to configure a DCPS connected to SeaGuardII or SmartGuard when using AADI Real-Time Collector.

CHAPTER 4 is how to log data using AADI Real-Time Collector.

CHAPTER 5 is an overview of how to configure a stand-alone DCPS when using terminal software like Tera Term.

CHAPTER 6 gives information about software versions and Stand-alone use.

CHAPTER 7 gives information on Cables and EMC guidelines.

CHAPTER 8 gives additional information for Acoustic Wave.

CHAPTER 9 gives information about other details such as sensor orientation and how to check the sensor.

CHAPTER 10 gives information about maintenance.

CHAPTER 11 gives information on installations and available accessories.

Applicable Documents

Form 572	Test & Specification Sheet
Form 859	Calibration Certificate, DCPS
Form 726	Calibration Certificate, Temperature Sensor 4080
Form 667	Pressure Certificate
D-409	Data Sheet SeaGuardII DCP
D-422	Data Sheet SeaGuardII DCP Wave
D-411	Data Sheet DCPS 5400/5400R, 5402/5402R, 5403/5403R
TD 310	Theoretical Primer for Doppler Current Profiler
TD 303	Manual for SeaGuardII Platform
TD 312	Configuration guide for DCPS and SeaGuardII DCP
TD 268	AADI Real-Time collector operating manual
TD 293	Operating manual SmartGuard

Abbreviations

AiCaP	Aanderaa Protocol: Automated idle Line CANbus Protocol
ASCII	American Standard Code for Information Interchange
CAN	Controller Area Network - sometimes referred to as CANbus
COM port	Communication port used for Serial communication RS232/RS422
DCPS	Doppler Current Profiler Sensor
DCS	Doppler Current Sensor (Single point)
EMC	Electromagnetic compatibility
EIA	Electronic Industry Alliance
GND	Ground
hPa	Hectopascal unit for measuring pressure, 1hPa=1mbar
Hz	Hertz is the derived unit of frequency in the International System of Units (SI)
kPa	Kilopascal unit for measuring pressure
mbar	Millibar unit for measuring pressure, 1mbar=1hPa
NOAA	National Oceanic and Atmospheric Administration
PSU	Practical Salinity Unit
RS-232	Recommended Standard 232 refers to a standard for serial communication of data
RS-422	Differential serial communication for longer cables
RXD	Serial communication Received data
SD-Card	Secure Digital Card a storage device used to store data
TXD	Serial communication Transmitted data
USB	Universal Serial Bus
QA	Quality Assurance, how it establishes a set of requirements for creating reliable products.
QC	Quality Control, the operational techniques and activities used to fulfil requirements for quality

CHAPTER 1 Short description and specifications of the DCPS

1.1 Description

The Aanderaa Doppler Current Profiler Sensor is an acoustic current profiling sensor based on the Doppler shift principle. It can operate either in narrowband or in broadband mode; the two measurement techniques are described in TD 310, Primer for Doppler Current Profiler. Broadband is only recommended to use in fixed installation, not on moving platforms.

To measure current speed and direction the sensor transmits acoustic pulses into the water and samples the backscattered (echo) signal from different distances away from the sensor. The sampled data from the received signal is processed to find the Doppler shift in the different layers/cells away from the sensor. It uses four acoustic transducers (beams) to be able to calculate the 3D-current in each layer/cell. Only 3 beams are necessary to obtain a 3D-current measurement and the 4th beam is used for additional quality controls (more information available in the TD 310).

The acoustic profiling range depends on the acoustic backscatter conditions, i.e. how much particles, plankton, air bubbles etc. present in the water column along the sensor beams. The DCPS operates at a 600 kHz frequency which gives typical profiling range from 40 to 80 meters from the sensor with good backscatter conditions. Extremely good backscatter conditions may give even longer profiling range while low backscatter can reduce the measurement range.

The sensor includes a solid-state 3-axis magnetometer and inclinometer providing the tilting and compass heading of the sensor. The tilt is necessary for correct placement of the cells away from the sensor and the correct calculation of the 3D-current components. The compass also uses the tilt internally to find the correct horizontal components of the earth magnetic field to be able to calculate the correct compass heading from the earth magnetic field.

The compass heading and tilt (pitch, roll) is measured for each acoustic ping and is used for calculation of the current vectors (north, east and vertical) for each ping. At the end of the recording interval a vector average is calculated for each cell to obtain the correct averaged horizontal speed and direction. The sensor can also output the horizontal north and east speed components in addition to the horizontal speed and direction.

In addition to the 4-beam calculation for current speed and direction, the sensor can also calculate and output all the four different 3-beam solutions. This can be useful as quality control of the data and to check if one of the beams has any kind of disturbance in one or several cells. An auto-beam solution can also be enabled; in this case the sensor uses a specific algorithm and define, for each cell and each ping, the best beam solution automatically (based on the use of 3 or 4 beams depending on the disturbance).

To measure wave you will need a SeaGuardII Platform with Pressure Sensor 4117, Tide Sensor 5217 or Wave & Tide Sensor 5218 and DCPS with Wave software 5759. If there are any wave movement on the surface we recommend using Tide or Wave and Tide sensor and not Pressure Sensor. Pressure sensor is doing a point measurement and are not compensating for wave movements. Acoustic wave is not available from a stand-alone DCPS and only in AiCaP mode. By using Wave and Tide Sensor 5218 you will also get redundant wave measurement for QA/QC. We recommend to use Tide measurements for surface reference since Pressure sensor do a point measurement and don't compensate for any wave movements, The measurement of waves and current are independent even though they using the same transducers. The interval for waves and current are selectable by user. The standard ping frequency when measuring waves are 4Hz, user selectable option for 2Hz. The transmission pulse is automatically adapted to the current sea conditions to provide best measurement achievable; a low noise broadband mode is used for smaller waves, an extended range broadband mode used for medium range waves and a narrowband mode is applied for higher waves.

The sensor also calculates and outputs several quality data which can be used to identify any suspicious data (user enabled). The different quality data from the sensor are described in details in this manual. If the user chooses to not enable all the quality data, the sensor always outputs a *Cell State1* and *Cell State2* parameter for each cell and a *Record State* for each measurement output. These status parameters indicate if the conditions have been good or not.

The DCPS 5400 sensor (300 meter version) has a POM Housing and titanium base plate while DCPS 5402 and DCPS 5403 also have titanium housing. The DCPS 5403 has a higher titanium grade (grade 5) than DCPS 5402 (grade 2) and withstand higher pressure.

The sensor is available in two versions either the standard version 5400, 5402 and 5403 with AiCaP and RS-232 output or an R-version, 5400R, 5402R and 5403R with RS-422. This sensor is intended for use as stand-alone sensor on longer cable since the cable length for RS-232 is limited especially with higher baudrate.

1.2 Sensor Dimension

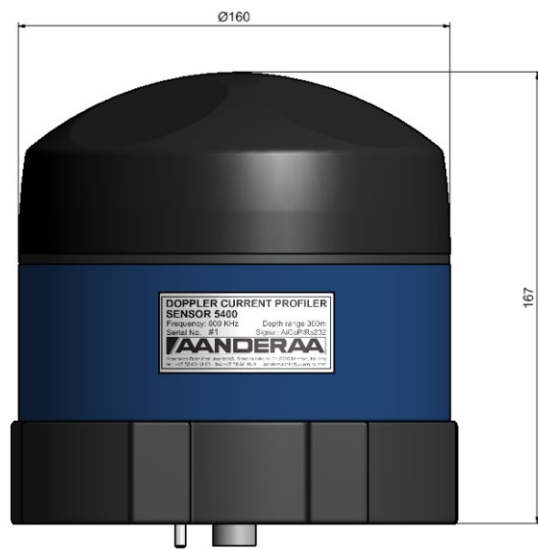
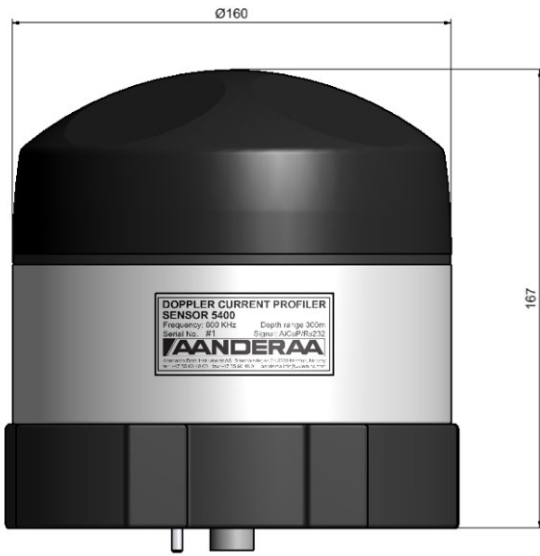

Figure 1-1: Sensor Dimension SW version

Figure 1-2: Sensor Dimension IW/DW version

1.3 Sensor pin configuration and data output

DCPS 5400/5402/5403 are using a 10-pin lemo plug for RS-232 and AiCaP communication between sensor and logger; see **Figure 1-3** for pin configuration. DCPS 5400R/5402R/5403R is using a 10-pin lemo plug for RS-422 connection to external logger; see **Figure 1-4** for pin configuration. For a list of available cables see **chapter 11.2** or contact aanderaa.sales@xylem.com.

1.3.1 Sensor pin configuration 5400/5402/5403 with RS-232 and AiCaP communication

PIN CONFIGURATION 5400/5402/5403

Receptacle, exterior view; pin = ● bushing = ○

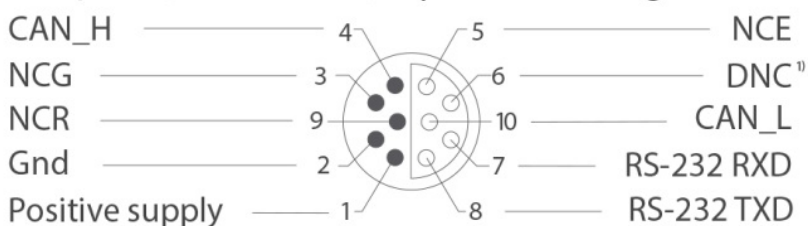

DNC¹⁾ = Do Not Connect

Figure 1-3 5400/5402/5403 Sensor communication 10-pin plug with RS-232 and AiCaP

Sensor Signal name	Input (I) Output (O)	Sensor plug MCBH10M. Pin no:
TXD	O	8
RXD	I	7
Positive supply		1
GND		2
NCE		5
NCR		9
NCG		3
CAN_H		4
CAN_L		10
BOOT ENABLE	I	6

Table 1-1: 5400/5402/5403 Sensor pin configuration 10-pin plug AiCaP and RS-232

1.3.2 Sensor pin configuration 5400R/5402R/5403R with RS-422 communication

PIN CONFIGURATION 5400R/5402R/5403R

Receptacle, exterior view; pin = ● bushing = ○

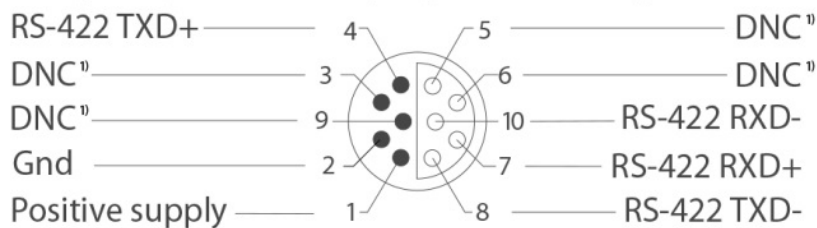

DNC¹⁾ = Do Not Connect

Figure 1-4 5400R/5402R/5403R Sensor communication 10-pin plug with RS-422

Signal name	Input (I) Output (O)	Sensor plug Pin no: MCBH6F
RX-	I	10
RXD/RX+	I	7
TXD/TX-	O	8
TX+	O	4
GND		2
Positive supply		1

Table 1-2: 5400R/5402R/5403R Sensor pin configuration 10-pin plug RS-422

1.4 Sensor Connection

Aanderaa offers a wide range of cables for different use of the sensors, both standard cables for use with loggers using AiCaP, RS-232 and RS-422 but also special customer specified cables for use in project. See **chapter 11.2** for an overview of standard cables or contact aanderaa.sales@xylem.com for more info. To configure the sensor it either need to be connected to an Aanderaa logger using AiCaP, a real-time RS-232/RS-422 cable or you need a RS-232 configuration cable. This cable can be used for all sensors regardless of version since all sensors have a RS-232 connection for configuration.

1.4.1 Configure sensor using RS-232 configuration cable

The 3855 cable is a non-watertight 1.5 meter cable for laboratory use only used for connection between sensor and PC in the office/lab. This cable can also be used to configure all other Aanderaa Smart Sensors.

The cable is supplied with a USB port providing power to the sensor but since the USB port on a computer normally gives 5V power and the DCPS needs 6-14V the sensor cannot be powered from the computer like for most other Aanderaa Smart Sensors. A USB extension is supplied with the cable so we recommend connecting the free end to an external power (6-14V). An alternative solution is *to use a 9V alkaline battery (6LF22) to set the sensor up or log it in the laboratory*. Sensor Cable 3855 is also available in other lengths.

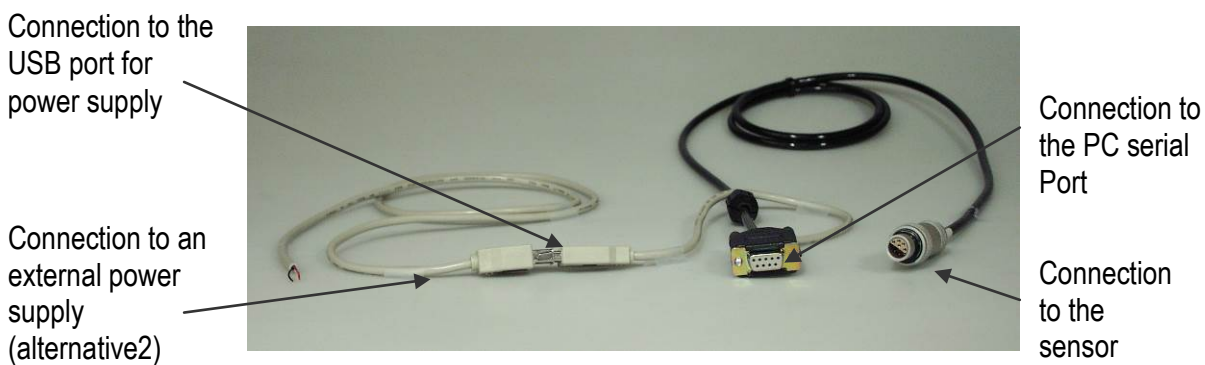

Figure 1-5: Configuration Cable 3855

Signal name	Sensor plug	9-p D-Sub	USB
TXD	1	2	
RXD	2	3	
Boot Enable	3		
BV	4		4 (black)
GND	7	5	1 (red)
Positive Supply	8		
RTS short to CTS		7-8	
DSR short to DTR		6-4	

Table 1-3: 3855 Cable pin configuration

1.5 User accessible sensor properties

All configuration settings that determine the behaviour of the sensor are called properties and are stored in a persistent memory block (flash). One property can contain several data elements of equal type (Boolean, character, integer etc.). The different properties also have different access levels.

To read the value of a certain properties you need to send ASCII string starting with the command get and then followed by the property name to the sensor, see example below.

To change the content of a property an ASCII string starting with set and then followed by the property name and new value in brackets need to be sent to the sensor.

Get Interval

//When sending this string to the sensor, it will then return the value stored in this property.

Interval 5400 17 1min

//Returned from sensor, where 5400 is the product number, 17 is the serial number of the sensor and 1min is the value stored as interval. To change the value you might send the following command:

Set Interval(10min)

//This will change the value for this property to 10 minutes

Save

//Always end with save to store setting in flash

The interval will now be changed to 10 minutes.

For more details see CHAPTER 5

1.6 Passkey for write protection

To avoid accidental change, most of the properties are write-protected. There are four levels of access protection, refer [Table 1-4](#).

A special property called **Passkey** must be set according to the protection level before changing the value of properties that are write-protected, refer [Table 1-4](#). After a period of inactivity at the serial input, the access level will revert to default. This period corresponds to the **Comm TimeOut** setting, or 1 minutes if the **Comm TimeOut** is set to **Always On**.

Output	Passkey	Description
No		No Passkey needed for changing property
Low	1	The Passkey must be set to 1 prior to changing property
High	1000	The Passkey must be set to 1000 prior to changing property This Passkey value also gives read access to factory properties that usually are hidden
Read Only	Factory	The user have only read access

Table 1-4: Passkey protection

1.7 Sensor Properties

When using AADI Real-Time Collector you don't need to think about the command string sent to the sensor since this is fully controlled by the software, see CHAPTER 2 and CHAPTER 3.

Some properties of the 'AiCaP' sensor will not be applicable / visible when the sensor is connected to a SeaGuardII or SmartGuard Datalogger, as these properties will be controlled by the instrument.

The wave properties are only applicable / visible if used in AiCaP mode and Acoustic Wave is enabled; see CHAPTER 8 for more details. To enable Acoustic Wave you need to order and enter the Acoustic Wave License Key. For older versions of DCPS a hardware upgrade might also be needed. Please contact aanderaa.sales@xylem.com for assistance.

All sensor properties are listed in chapters 1.7.1 through 1.7.4.

1.7.1 Factory Configuration

All properties in this section are Read Only, not possible to overwrite for the user. Only certified Aanderaa service personal can alter these settings. The access level for reading the status of this properties are however different for each property, see table for more details. In this group we find information about Software and hardware settings, Production, Service and Calibration dates and limits for quality parameters where status will be shown in [Cell State 1](#), [Cell State 2](#) and [Record Status](#). See chapter 5.6.2 for more details.

Table 1-5: Sensor properties for Doppler Current Profiler Sensor 5400/5400R, 5402/5402R, and 5403/5403R

ENUM=Enumeration, INT=Integer, BOOL=Boolean ('yes'/'no')

Property	Type	No of elements	Use	Configuration Category	Access Protection Read/Write
<i>Product Name</i>	String	31	AAID Product name, default Doppler Current Profiler Sensor	FC	No / Read Only
<i>Product Number</i>	String	6	AAID Product number, default 5400, 5400R, 5402, 5402R, 5300 or 5300R		
<i>Serial Number</i>	INT	1	Serial Number		
<i>SW ID</i>	String	11	Unique identifier for internal firmware		
<i>SW Version</i>	INT	3	Software version (Major, Minor, Built)		
<i>HW ID X</i>	String	19	Hardware Identifier, X =1..3 ¹⁾ unique identifier for hardware		High / Read Only
<i>HW Version X</i>	String	9	Hardware Identifier, X =1..3 ¹⁾ (Rev. x)		
<i>System Control</i>	INT	3	For AAID service personnel only		
<i>Production Date</i>	String	31	AAID production date, format YYYY-MM-DD (Not in use)		
<i>Last Service</i>	String	31	Last service date, format YYYY-MM-DD, empty by default		
<i>Last Calibration</i>	String	31	Last calibration date, format YYYY-MM-DD (Not in use)		High / Read Only
<i>Calibration Interval</i>	INT	1	Recommended calibration interval in days (Not in use)		
<i>Cross Diff Limits</i>	INT	3	Set limits 1, 2, and 3 for “Cell has High cross difference, above cross difference limit”, default values are 10, 25 and 40. If value exceeds the limits a bit in Cell State1 will be set. See Cell State definition in Table 5-5 .		
<i>Strength Limits NB</i>	INT	4	Set limits 1, 2, 3 and Discard Data ²⁾ for “Cell has weak signal, strength below weak limit for narrowband”, default values are -40, -44, -48 and -50. If value exceeds the limits a bit in Cell State1 will be set. If Beam Strength Output is set a status for each individual beam will be shown in Cell State 2. See Cell State definition in Table 5-6 .		

<i>Strength Limits BB</i>	INT	4	Set limits 1, 2, 3 and Discard Data ²⁾ for “Cell has weak signal, strength below weak limit for broadband”, default values are -40, -44, -48 and -50. If value exceeds the limits a bit in Cell State will be set. If Beam Strength Output is set a status for each individual beam will be shown in Cell State 2. See Cell State definition in Table 5-6 .	FC	High / Read Only
<i>SP Stdev Limits NB</i>	INT	3	Set limits 1, 2 and 3 for “Cell has high standard deviation for narrowband”, default values are 60, 80 and 100. If value exceeds the limits a bit in Cell State 1 will be set. See Cell State definition in Table 5-5 .		
<i>SP Stdev Limits BB</i>	INT	3	Set limits 1, 2 and 3 for “Cell has high standard deviation for broadband”, default values are 10, 30 and 50. If value exceeds the limits a bit in Cell State1 will be set. See Cell State definition in Table 5-5 .		
<i>Vertical Current Limits</i>	INT	3	Set limits 1, 2, 3 and for “Cell has High vertical current above high vertical limit”, default values are 10, 20 and 30. If value exceeds the limits a bit in Cell State1 will be set. See Cell State definition in Table 5-5 .		
<i>Cross Correlation High Limit</i>	INT	2	Set high limit for “broadband cross correlation beam1-beam4, outside cross correlation limit”, default values are 0.6. If value exceeds the limits a bit in Cell State1 will be set for each individual beam. See Cell State definition in Table 5-5 .		
<i>Noise Limit 1</i>	INT	1	Set limit for “High ambient noise measured on Beam1 – Beam4”, default values are -48. If Noise Level Output is enabled and value exceeds the limits a bit in Record Status will be set for each individual beam. See Record Status definition in Table 5-7 .		
<i>Noise Limit 2</i>	INT	1	Set limit for “Higher ambient noise measured on Beam1 – Beam4”, default values are -38. If value exceeds the limits a bit in Record Status will be set for each individual beam. See Record Status definition in Table 5-7 .		
<i>Noise Limit 3</i>	INT	1	Set limit for “Even higher ambient noise measured on Beam1 – Beam4”, default values are -28. If exceeds the limits a bit in Record Status will be set for each individual beam. See Record Status definition in Table 5-7 .		
<i>Air Detect Threshold</i>	INT	1	Set limits for air detect, default values are 500. Used to disable ping pulse from the transducers when sensor is in air. If value exceeds the limits a bit in Record Status will be set. See Record Status definition in Table 5-7 .		

¹⁾ Hardware ID 1 is Analog Board for Transducer 1 and 2. Hardware ID 2 is Analog Board for Transducer 3 and 4 and Hardware ID 3 is for Digital Board

²⁾ When value exceeds the Discard Data limit, Discard Data will also be output in parameter status.

1.7.2 Deployment Settings

Deployment Settings contains settings for instruments metadata like position and owner, but also site dependent properties storing data that might influence the measurement. Value stored in these setting can be used as default values but might also be exchanged with real-time measured data if sensors are connected to the AiCaP bus.

Table 1-6: Sensor properties for Doppler Current Profiler Sensor 5400/5400R, 5402/5402R, and 5403/5403R

ENUM=Enumeration, INT =Integer, BOOL=Boolean ('yes'/'no')

Table 1-1 Property	Type	No of elements	Use	Configuration Category	Access Protection Read/Write
<i>Interval</i>	ENUM	1	Set the output interval in seconds, minutes or hours. Minimum available interval is dependent on configuration (time to do all ping measurements). ¹⁾	DS	No / No
<i>Location</i>	String	31	User setting for location		
<i>Geographic Position</i>	String	31	User setting for geographic position		
<i>Vertical Position</i>	String	31	User setting for describing sensors vertical position/depth		
<i>Reference</i>	String	31	User setting for describing sensor reference, user definable.		
<i>Enable Magnetic Declination</i>	BOOL	1	Enables use of magnetic declination angle input (see Declination Angle for value used) ²⁾		No / Low
<i>Declination Angle</i>	Float	1	A value to correct for the magnetic variation on the site where the sensor is used. This is the angle in degrees between magnetic north and true north. ²⁾		
<i>Sound Speed</i>	Float	1	Fixed sound speed setting in m/s. This value is used for cell positioning in the profile and for calculation of current speed values. Variable sound speed values can be used while sensor is running. ³⁾⁴⁾		
<i>Air Pressure</i>	Float	1	The air pressure in kPa. The air pressure value is used when calculating depth. Can be altered while sensor is running to compensate for variable air pressure.		
<i>Local Gravity Constant</i>	Float	1	Gravity constant in m/s ² used for calculation of depth.		
<i>Salinity</i>	Float	1	Salinity in PSU used for calculation of density, sound speed and depth. Can be altered while sensor is running to compensate for variable salinity. ³⁾		
<i>Fixed Installation Pressure</i>	Float	1	The pressure in kPa at the deployment site. Can be altered while sensor is running to compensate for variable pressure. ³⁾ This value is used for calculation of depth if the surface cell or surface reference is enabled without parameter input from a pressure sensor. ⁵⁾⁶⁾ Not recommended.		

<i>Temperature</i>	Float	1	The temperature in degree centigrade. The value is used for calculation of Salinity, Sound speed and Density. Can be altered while sensor is running to compensate for variable temperature. ³⁾	DS	No / Low
<i>Enable Derived Sound Speed</i>	BOOL	1	If enabled it will calculate the sound speed from the other available sensors or fixed values. This overrides the Sound Speed setting. If a parameter is available from another sensor it will use this in the calculation, otherwise it will use the fixed value.		
<i>Pressure Sensor Id</i>	ENUM	1	When the DCPS is connected to AiCaP, a list of other available sensors connected to the SmartGuard/SeaGuard Datalogger is shown. This makes it possible to get a correct depth input from another sensor through the datalogger ⁷⁾ Only in AiCaP mode		
<i>Pressure Parameter Id</i>	ENUM	1	A list of all available Pressure parameters with kPa as unit is shown in the dropdown menu. Make sure that the correct pressure parameter is selected. Only in AiCaP mode.		
<i>Air Pressure Sensor Id</i>	ENUM	1	When the DCPS is connected to AiCaP, a list of other available sensors connected to the SmartGuard/SeaGuard Datalogger is shown. This makes it possible to get a correct air pressure input from another sensor through the datalogger ⁷⁾ Only in AiCaP mode		
<i>Air Pressure Parameter Id</i>	ENUM	1	A list of all available Air Pressure parameters with hPa or mbar as unit is shown in the dropdown menu. Make sure that the correct pressure parameter is selected. Only in AiCaP mode.		
<i>Temperature Sensor Id</i>	ENUM	1	When the DCPS is connected to AiCaP, a list of other available sensors connected to the SmartGuard/SeaGuard Datalogger is shown. This makes it possible to get a correct temperature input from another sensor through the datalogger ⁷⁾ Only in AiCaP mode		
<i>Temperature Parameter Id</i>	ENUM	1	A list of all available Temperature parameters with DegC or Deg.C as unit is shown in the dropdown menu. Make sure that the correct temperature parameter is selected. Only in AiCaP mode.		
<i>Conductivity Sensor Id</i>	ENUM	1	When the DCPS is connected to AiCaP, a list of other available sensors connected to the SmartGuard/SeaGuard Datalogger is shown. This makes it possible to get a correct conductivity input from another sensor through the datalogger ⁷⁾ Only in AiCaP mode		
<i>Conductivity Parameter Id</i>	ENUM	1	A list of all available Conductivity parameters with mS/cm as unit is shown in the dropdown menu. Make sure that the correct conductivity parameter is selected. Only in AiCaP mode.		
<i>Heading Sensor Id</i>	ENUM	1	When the DCPS is connected to AiCaP, a list of other available sensors connected to the SmartGuard/SeaGuard Datalogger is shown. This makes it possible to get a correct heading input from another sensor through the datalogger ⁷⁾ Only in AiCaP mode		

<i>Heading Parameter Id</i>	ENUM	1	A list of all available Heading parameters with Deg.M as unit is shown in the dropdown menu. Make sure that the correct heading parameter is selected. Only in AiCaP mode.	DS	No/ Low
<i>Heading Alignment Offset[Deg.M]</i>	Float	1	Offset added to the AiCaP external heading. Only in AiCaP mode.		

- 1) *The interval is an enumerated type. On Software versions prior to version 8.1.27 this was not enumerated but restricted to the same intervals. The enumerated value for the Interval is shown when sending a Help command to the sensor (10 sec, 20 sec, 30 sec, 1 min, 2 min etc.) On Software version before version 8.1.27 the interval input was only the number of seconds without time unit, i.e 10 was 10 seconds, 60 if 1 minute, 3600 if 1 hour etc.*
- 2) *Magnetic declination (variation) is the angle between the magnetic north and the true north. This angle varies depending on the position on the Earth's surface and also varies over time. Declination is positive when magnetic north is east of true north and negative when it is to the west (input angle value $\pm 180^\circ$). Magnetic declination at the deployment location can be found for i.e. on NOAA website: <http://www.ngdc.noaa.gov/geomag-web/>*
- 3) *The sensor can compensate for variable Temperature, Conductivity and Pressure when installed on a SeaGuardII or SmartGuard Datalogger. If the Datalogger has these sensors connected, the DCPS5400 can be configured to take the input from these sensors to calculate Depth, Salinity, Density and Sound Speed. The calculated depth is also used when surface cell and surface referred columns are enabled. If only some of the sensors are present, the DCPS can also combine sensor inputs and settings to calculate the derived sound speed. See Chapter 5.4 for explanation of Parameter Input when connected to a SeaGuardII or SmartGuard Datalogger.*
- 4) *The accuracy of the estimated current speeds depends on a correct sound speed setting. The cell positioning also depends on the sound speed. The best way to compensate for variable sound speed is described above in 1).*
- 5) *A Pressure/Tide/Wave&Tide sensor which is connected to the same SmartGuard/SeaGuardII can be used as parameter input to the DCPS-sensor to give the calculated depth. If no pressure sensor is available, the Fixed Installation Pressure is used by the sensor if the surface cell or the surface reference is enabled. The Fixed Installation Pressure can be changed while the sensor is running by an external device.*
- 6) *Even though the user should configure the sensor as upward or downward looking, the sensor detects automatically the orientation when it is in operation. It uses this orientation to calculate the correct North, East and Vertical speeds and also for the calculation of correct compass heading, pitch and roll. If the sensor detects that it is upside down (while configured upward looking and surface referred), the surface cell parameters are set to zero and the parameter status codes returns a "not valid error". If one of the columns is set to surface reference, the column is forced to be instrument referred. If the sensor is configured to be upside down but measures that it is orientated upward looking, both surface cell and surface reference will work if enabled. The 'record status' (in the output data) will indicate in the first bit (32-bit where 32 flags indicates different statuses) with a '1' if there is a mismatch between the upside down setting and the orientation measured by the sensor (binary bits xxxxxxxxxxxxxxxxxxxxxxxxxxxxxxx1, where x are the other bits indicating other statuses).*
- 7) *The fixed heading value here is the angle in degrees between north direction and transducer 1 (clockwise) – Refer Figure 6-2. When viewing the sensor from the front (label side) transducer 1 is to the left on the rear side. If for example transducer 1 is 118° clockwise from north, the fixed heading should be set to 118°. The fixed heading is a value between 0 and 360 (0 and 360 is the same point).*

1.7.3 System Configuration

This group is used to control the sensor via properties for configuring communication with logger, sensor setup and parameter enabling and controlling the output from sensor. Some of the properties are only visible depending on the mode selected or if the function is enabled or not. These properties will either be grey or not visible at all. The wave properties are only visible if a license key is set.

Table 1-7: Sensor properties for Doppler Current Profiler Sensor 5400/5400R, 5402/5402R, and 5403/5403R

ENUM=Enumeration, INT=Integer, BOOL=Boolean ('yes'/'no')

Table 1-1 Property	Type	No of elements	Use	Configuration Category	Access Protection Read/Write
<i>Mode</i>	ENUM	1	Sets the sensor operation mode (AiCaP, Smart Sensor Terminal and AADI Real-Time). AiCaP is not available on the R-version (5400R) of the sensor. Smart Sensor Terminal is an ASCII output when AADI Real-Time is XML output.	SC	No / Low
<i>Enable Sleep</i>	BOOL	1	Enables sleep mode in Smart Sensor Terminal and AADI Real-Time operation to save power (In AiCaP the sensor always tries to sleep when not busy).		
<i>Enable Polled Mode</i>	BOOL	1	Enables polled mode in Smart Sensor Terminal Mode. When set to 'no' (non-polled operation) the sensor will sample at the interval given by the <i>Interval</i> property. When set to 'yes' the sensor will start to do ping measurements at the selected <i>Polled Pingrate</i> . A <i>Do Sample</i> command triggers the end calculations and output of data. A <i>Do Output</i> command can be sent to repeat the output of the last calculated data. ¹⁾		
<i>Polled Pingrate</i>	ENUM	1	Selectable ping rate in Polled mode between 0.1 and 10.0 Hz. The maximum ping rate is limited by the configuration, i.e. large profile with many cells gives lower maximum available pingrate. ¹⁾ Default is 1 Hz.		No / No
<i>Enable Text</i>	BOOL	1	Controls the insertion of descriptive text in Smart Sensor Terminal mode, i.e. parameter names and units. Can be used to reduce message size.		No / Low
<i>Enable Decimalformat</i>	BOOL	1	Controls the use of decimal format in the output string in Smart Sensor Terminal mode. Default is scientific format (exponential format).		
<i>Enable Tilt Compensation</i>	BOOL	1	Tilt compensation is used for correct positioning of the beam cells in each depth cell. It also compensates the Doppler speed measurements for variable tilt to calculate correct speed components (North, East and Vertical). Default enabled.		
<i>Enable Fixed Heading</i>	BOOL	1	Allows the user to deactivate the internal compass and set a fixed heading value. This can be used if for example the sensor is standing on a fixed platform where the earth magnetic field is disturbed. ²⁾		

<i>Fixed Heading</i> [Deg.M]	Float	1	The fixed heading value is used if fixed heading is enabled. ²⁾	SC	No / Low
<i>Enable Upside Down</i>	BOOL	1	Set to 'No' if used upward looking and 'Yes' if used downward looking. Uses different calibration coefficient set depending on setting. NOTE! Surface Cell and Surface Referred Columns are not possible when sensor is downward looking. ³⁾		
<i>Enable Wave Measurement</i>	BOOL	1	Turns on and of the wave measurements. Only available when Wave software 5729 is enabled with Wave License Key and used in AiCaP mode and at least a pressure sensor are connected to the same bus.		No / No
<i>Wave Integration Time</i>	ENUM	1	Integration time used for wave calculation. 5 min,10 min,15 min,20 min,25 min,30 min. Default is 20min. Only available when Wave software 5729 is enabled with Wave License Key and used in AiCaP mode and at least a pressure sensor are connected to the same bus.		
<i>Wave Sampling Frequency</i>	ENUM	1	Selectable between 2Hz and 4Hz sampling. Default is 4Hz. Only available when Wave software 5729 is enabled with Wave License Key and used in AiCaP mode and at least a pressure sensor are connected to the same bus.		
<i>Significant Wave Height Unit</i>	ENUM	1	Select units for Significant wave height to either Metric (meter) or Imperial (feet). Default setting is Metrics (meter). Only available when Wave software 5729 is enabled with Wave License Key and used in AiCaP mode and at least a pressure sensor are connected to the same bus.		
<i>Bandwidth</i>	ENUM	1	Selects between <i>Broadband</i> and <i>Narrowband</i> operation. See Chapter 2.4.4 or 3.6.3 for explanation.		No / Low
<i>Enable Ambiguity Lock</i>	BOOL	1	Locks the Broadband algorithm to the speed interval between 0 and 1.2m/s. Should be used if the user knows that the current speeds are always below 1.2m/s.		
<i>Ping Number</i>	ENUM	1	The number of ping measurements to be executed in one interval (set by interval property), i.e. the number of ping measurements to be averaged in one recording. Selectable from 10 to 7200. Note that the number of ping needed in broadband is a factor 30 lower compared to narrowband.		No / No
<i>Enable Burst Mode</i>	BOOL	1	If set to 'No', the pings are uniformly spread over the interval. If set to 'Yes' the pings are transmitted at the beginning or end of the interval. ⁴⁾		
<i>Burst Period Placement</i>	ENUM	1	If set to "Start of Interval" all pings will be transmitted in the beginning of the interval but presented in the end. If set to "End of Interval" it will transmit all pings in the end of the interval close to the read out. Default setting is End of Interval. Only available if Enable Burst Mode is selected.		
<i>Enable Surface Cell</i>	BOOL	1	Enables a measurement of the surface layer. This layer is based on the strong reflection from the thin layer between water and air. There will be a strong correlation between wind and speed/surface boundary speed and wind direction / surface boundary direction.	No / Low	
<i>Surface Cell Size</i>	ENUM	1	The surface cell size around the surface layer. The time window where the sensor measures the Doppler is centred at the surface. Selectable from 0.5 to 5 meter. Default setting is 1 meter.		

<i>C1 Enable Surface Reference</i>	BOOL	1	Enables surface reference for Column 1. If not selected the column will be instrument referenced. Note! The sensor needs a pressure input to compensate for tidal variations. Cannot be used it in combination with downward orientation.	SC	No / Low
<i>C1 Cell Size</i>	ENUM	1	The Cell size setting for Column 1 in meter. Selectable from 0.5 to 5 meter. Default setting is 1 meter.		
<i>C1 Distance first Cell Center</i>	ENUM	1	The distance to centre of first cell for Column 1 in meter, distance from surface if surface referenced or sensor if not surface referenced. Always sensor referenced if used upside down. Selectable from 1 to 70 meter. Default setting is 3 meter.		
<i>C1 Number Of Cells</i>	ENUM	1	Number of Cells in Column 1, maximum 75 cells. Default setting is 45.		
<i>C1 Cell Center Spacing[m]</i>	ENUM	1	Spacing between two cells for Column 1 in meter. If spacing is equal to cell size the two cells is next to each other. Spacing less than cell size gives overlap and spacing more than cell size gives space between two cells. Selectable from 0.1 to 30 meter. Default setting is 1 meter.		
<i>C2 Enable Column</i>	BOOL	1	Enables Column 2 (Column 1 is always enabled)		
<i>C2 Enable Surface Reference</i>	BOOL	1	Enables surface reference for Column 2. If not selected the column will be instrument referenced. Note! The sensor needs a pressure input to compensate for tidal variations. Cannot be used it in combination with downward orientation.		
<i>C2 Cell Size</i>	ENUM	1	The Cell size setting for Column 2 in meter. Selectable from 0.5 to 5 meter. Default setting is 1 meter.		
<i>C2 Distance first Cell Center</i>	ENUM	1	The distance to centre of first cell for Column 2 in meter, distance from surface if surface referenced or sensor if not surface referenced. Always sensor referenced if used upside down. Selectable from 1 to 70 meter. Default setting is 3 meter.		
<i>C2 Number Of Cells</i>	ENUM	1	Number of Cells in Column 2, maximum 50 cells. Default setting is 10.		
<i>C2 Cell Center Spacing[m]</i>	ENUM	1	Spacing between two cells for Column 2 in meter. If spacing is equal to cell size the two cells is next to each other. Spacing less than cell size gives overlap and spacing more than cell size gives space between two cells. Selectable from 0.1 to 30 meter. Default setting is 2 meter.		
<i>C3 Enable Column</i>	BOOL	1	Enables Column 3		
<i>C3 Enable Surface Reference</i>	BOOL	1	Enables surface reference for Column 3. If not selected the column will be instrument referenced. Note! The sensor needs a pressure input to compensate for tidal variations. Cannot be used it in combination with downward orientation.		
<i>C3 Cell Size</i>	ENUM	1	The Cell size setting in Column 3 in meter. Selectable from 0.5 to 5 meter. Default setting is 1 meter.		

<i>C3 Distance first Cell</i>	ENUM	1	The distance to centre of first cell for Column 3 in meter, distance from surface if surface referenced or sensor if not surface referenced. Always sensor referenced if used upside down. Selectable from 1 to 70 meter. Default setting is 3 meter.	SC	No / Low
<i>C3 Number Of Cells</i>	ENUM	1	Number of Cells in Column 3, maximum 25 cells. Default setting is 10.		
<i>C3 Cell Center Spacing[m]</i>	ENUM	1	Spacing between two cells for Column 3 in meter. If spacing is equal to cell size the two cells is next to each other. Spacing less than cell size gives overlap and spacing more than cell size gives space between two cells. Selectable from 0.1 to 30 meter. Default setting is 2 meter.		
<i>Enable Current from Wave Ping</i>	BOOL	1	If enabled data from wave measurement will also be used to calculate current. All current data are presented in Column 4. Only in AiCaP mode and with Wave License Key.		
<i>Wave Mean Direction Output</i>	ENUM	1	Configuration of Wave Mean Dir Output Off, Storage or Output+Storage. Only in AiCaP and with Wave License Key.		
<i>Wave Mean Period Tm02 Output</i>	ENUM	1	Configuration of Wave Mean Period Tm02 Output 'Off, Storage or Output+Storage'. Only in AiCaP and with Wave License Key.		
<i>Wave Energy Period Tm-10 Output</i>	ENUM	1	Configuration of Wave Energy Period Tm-10 Output 'Off, Storage or Output+Storage'. Only in AiCaP and with Wave License Key.		
<i>Energy Spectrum Output</i>	ENUM	1	Configuration of Energy Spectrum Output 'Off, Storage or Output+Storage'. Only in AiCaP and with Wave License Key.		
<i>Directional Spectrum Output</i>	ENUM	1	Configuration of Directional Spectrum Output 'Off, Storage or Output+Storage'. Only in AiCaP and with Wave License Key.		
<i>Principal Dir Spectrum Output</i>	ENUM	1	Configuration of Principal Dir Spectrum Output 'Off, Storage or Output+Storage'. Only in AiCaP and with Wave License Key.		
<i>Orbital Ratio Spectrum Output</i>	ENUM	1	Configuration of Orbital Ratio Spectrum Output 'Off, Storage or Output+Storage'. Only in AiCaP and with Wave License Key.		
<i>Fourier Coeff Spectrum Output</i>	ENUM	1	Configuration of Fourier Coeff Spectrum Output 'Off, Storage or Output+Storage'. Only in AiCaP and with Wave License Key.		
<i>Wave Depth Cell Output</i>	ENUM	1	Configuration of Wave Depth Cell Output 'Off, Storage or Output+Storage'. Only in AiCaP and with Wave License Key.		

<i>Select Profile Parameters</i>	ENUM	1	Different groups of parameters that will control the output from sensor. If User Specified is selected you may select the individual parameter under User Specified – Profile Parameter. For all other selections the individual setting will be overruled by the group setting. Alternative choices are: Simple Output, Basic Output, Basic + Beam Output, Basic + 3-beam Output, Basic + Beam + 3-beam Output, Full Output, User Specified. See Table 2-1 or Table 3-1 for definition of each group.	SC	No / Low
<i>Enable 4-beam Auto Replacement</i>	BOOL	1	Enables automatic replacement of the standard 4-beams calculated result with the best 3-beams if any disturbance in one of the beams.		
<i>NE Speed Output</i>	ENUM	1	Enables/Disables output of calculated North and East speed components. ⁵⁾ 'Off' or 'Output' (in AiCaP Off, Storage or Output+Storage).		
<i>3-Beam Combination Output</i>	ENUM	1	Enables output of the four 3-Beam combinations. ⁵⁾ Each 3-Beam is calculated using only 3-transducers to help detect any obstructions in one of the beams. 'Off' or 'Output' (in AiCaP Off, Storage or Output+Storage).		
<i>AutoBeam Output</i>	ENUM	1	Enables output of the autobeam solution; the sensor uses a specific algorithm to define, for each cell and ping, the best beam solution automatically, based on the use of 3 or 4 beams depending on disturbance. ⁵⁾ 'Off' or 'Output' (in AiCaP Off, Storage or Output+Storage).		
<i>AutoBeam Speed Type</i>	ENUM	1	Sets the AutoBeam Speed Type. If AutoBeam Output is selected then AutoBeam Speed Type will select the output format. 'Polar', 'Rectangular' or 'Polar+Rectangular', See chapter 2.4.10 or 3.6.11		
<i>Vertical Speed Output</i>	ENUM	1	Enables output of calculated vertical speed ⁵⁾ 'Off' or 'Output' (in AiCaP Off, Storage or Output+Storage).		
<i>Strength Output</i>	ENUM	1	Enables the output of signal strength (Average from all beams). ⁵⁾ 'Off' or 'Output' (in AiCaP Off, Storage or Output+Storage).		
<i>Beam Speed Output</i>	ENUM	1	Enables output of speeds for each individual beam (m/s). ⁵⁾ 'Off' or 'Output' (in AiCaP Off, Storage or Output+Storage).		
<i>Beam Strength Output</i>	ENUM	1	Enables output of signal strength for each individual beam (dB). ⁵⁾ 'Off' or 'Output' (in AiCaP Off, Storage or Output+Storage).		
<i>Std Dev Speed Output</i>	ENUM	1	Enables standard deviation output for horizontal speed calculated in each cell. ⁵⁾ 'Off' or 'Output' (in AiCaP Off, Storage or Output+Storage).		
<i>Std Dev Beam Speed Output</i>	ENUM	1	Enables standard deviation output of beam speed for each beam in every cell. ⁵⁾ 'Off' or 'Output' (in AiCaP Off, Storage or Output+Storage).		

<i>Cross Difference Output</i>	ENUM	1	Enables cross difference output for all cells. ⁵⁾ Difference between Doppler shift measured by the transducers on same axis, for each depth the speed in beam 1 - speed beam 3 + speed beam 2 – speed beam 4 should be close to 0. 'Off' or 'Output' (in AiCaP Off, Storage or Output+Storage).	SC	No / Low
<i>Correlation Factor Output</i>	ENUM	1	Enables correlation factor output (only in Broadband). ⁵⁾ 'Off' or 'Output' (in AiCaP Off, Storage or Output+Storage).		
<i>Noise Level Output</i>	ENUM	1	Enables output of noise measurements from the four beams. This is a way to check for disturbance from other acoustic devices or input noise on the cable. ⁵⁾ 'Off' or 'Output' (in AiCaP Off, Storage or Output+Storage).		
<i>Heading Output</i>	ENUM	1	Enables output of the compass heading. ⁵⁾ 'Off' or 'Output' (in AiCaP Off, Storage or Output+Storage).		
<i>Pitch Roll Output</i>	ENUM	1	Enables output of pitch and roll rotation angles (deg.). ⁵⁾ 'Off' or 'Output' (in AiCaP Off, Storage or Output+Storage).		
<i>Abs Tilt Output</i>	ENUM	1	Enables output of the absolute tilt. This is the angle between the sensor plane and the horizontal plane (Deg.). ⁵⁾ 'Off' or 'Output' (in AiCaP Off, Storage or Output+Storage).		
<i>Max Tilt Output</i>	ENUM	1	Enables the output of the maximum absolute tilt measured (Deg.) during the recording interval. ⁵⁾ 'Off' or 'Output' (in AiCaP Off, Storage or Output+Storage).		
<i>Tilt Direction Output</i>	ENUM	1	Enables the output of the tilt direction of the sensor (Deg.M). ⁵⁾ 'Off' or 'Output' (in AiCaP Off, Storage or Output+Storage).		
<i>Std Dev Heading Output</i>	ENUM	1	Enables standard deviation on heading output. The sensor does one heading measurement for each ping. This is the standard deviation of all the heading measurements during a recording interval. ⁵⁾ 'Off' or 'Output' (in AiCaP Off, Storage or Output+Storage).		
<i>Std Dev Tilt output</i>	ENUM	1	Enables standard deviation on tilt output. The sensor does a tilt measurement for each ping. This is the standard deviation of all the absolute tilt measurements during the recording interval. ⁵⁾ 'Off' or 'Output' (in AiCaP Off, Storage or Output+Storage).		
<i>Temperature Output</i>	ENUM	1	Enables the output of Temperature from Temperature sensor 4080 in (Deg.C). Only available if the optional Temperature sensor 4080 is included and calibrated from factory. 'Off' or 'Output' (in AiCaP Off, Storage or Output+Storage).		
<i>Charge Voltage Output</i>	ENUM	1	Enables output of the charge voltage to the acoustic Tx circuits. This is a way to see if there is something wrong with the charge electronics or the transducers. ⁵⁾ 'Off' or 'Output' (in AiCaP Off, Storage or Output+Storage).		
<i>Memory Used Output</i>	ENUM	1	Enables output of the used heap memory. ⁵⁾ 'Off' or 'Output' (in AiCaP Off, Storage or Output+Storage).		

Voltage Output	ENUM	1	Enables output of the measured input voltage internally in the sensor. This is a way to see if the input supply voltage starts dropping. ⁵⁾ 'Off' or 'Output' (in AiCaP Off, Storage or Output+Storage).	SC	No / Low
Current Output	ENUM	1	Enables output of the measured input current to the sensor. This can indicate if something is wrong in the internal electronics if it suddenly starts to rise. ⁵⁾ 'Off' or 'Output' (in AiCaP Off, Storage or Output+Storage).		
Air Detect Output	ENUM	1	Outputs the value measured by the air detect circuit. This is a circuit which detects if the sensor is in air or water. ⁵⁾ 'Off' or 'Output' (in AiCaP Off, Storage or Output+Storage).		
Speed Of Sound Output	ENUM	1	Enables output of the speed of sound. If Derived Sound Speed is enabled, this is the value calculated from the other input settings. (or sensors in AiCaP). If not, it outputs the sound speed setting. ⁶⁾⁷⁾⁵⁾ 'Off' or 'Output' (in AiCaP Off, Storage or Output+Storage).		
Depth Output	ENUM	1	Enables depth output. This is the calculated depth, i.e. calculated from other settings (or sensors in AiCaP). ⁶⁾⁵⁾ 'Off' or 'Output' (in AiCaP Off, Storage or Output+Storage).		
Salinity Output	ENUM	1	Enables salinity output. In AiCaP the sensor can get input from a Conductivity, Temperature and Pressure Sensor. This enables the sensor to calculate the salinity. If no sensors are present, it outputs the salinity setting. ⁶⁾⁵⁾ 'Off' or 'Output' (in AiCaP Off, Storage or Output+Storage).		
Density Output	ENUM	1	Enables output of calculated density. This is either based on sensor input (in AiCaP) or fixed settings. ⁶⁾⁵⁾ 'Off' or 'Output' (in AiCaP Off, Storage or Output+Storage).		

¹⁾ In Polled Mode the sensor uses the Polled Pingrate setting. In non-polled operation the sensor uses the Interval property and the Ping Number property to calculate the ping rate. This is an enumerated value. The selectable ping rate is shown when sending a Help command to the sensor or in the drop-down list shown in Real-Time Collector. The input has to be written as shown with Hz as unit. This value was not enumerated on software versions prior to version 8.1.27. On earlier software versions the values were restricted to the same ping rates (written without unit) but not shown as an enumerated list when sending a Help command or changing the setting in Real-Time Collector.

²⁾ The fixed heading value here is the angle in degrees between north direction and transducer 1 (clockwise) – Refer Figure 6-2. When viewing the sensor from the front (label side) transducer 1 is to the left on the rear side. If for example transducer 1 is 118° clockwise from north, the fixed heading should be set to 118°. The fixed heading is a value between 0 and 360 (0 and 360 is the same point).

³⁾ Even though the user should configure the sensor as upward or downward looking, the sensor detects automatically the orientation when it is in operation. It uses this orientation to calculate the correct North, East and Vertical speeds and also for the calculation of correct compass heading, pitch and roll. If the sensor detects that it is upside down (while configured upward looking and surface referred), the surface cell parameters are set to zero and the parameter status codes returns a “not valid error”. If one of the columns is set to surface reference, the column is forced to be instrument referred. If the sensor is configured to be upside down but measures that it is orientated upward looking, both surface cell and surface reference will work if enabled. The ‘record status’ (in the output data) will indicate in the first bit

(32-bit where 32 flags indicates different statuses) with a '1' if there is a mismatch between the upside down setting and the orientation measured by the sensor (binary bits xxxxxxxxxxxxxxxxxxxxxxxxxxxxxxx1, where x are the other bits indicating other statuses).

- 4) The burst mode should be enabled when using a longer interval where the user does not want to average the current over the entire interval. The burst duration for executing all the pings is dependent on the configuration of the sensor (profile size, number of columns, number of cells and number of ping).
- 5) The enumeration is Off, Output in Smart Sensor Terminal and AADI Real-Time mode. In AiCaP the enumeration is Off, Storage, Output+Storage, where Output+Storage means that the sensor instructs the Datalogger to send out a parameter in real-time in addition to saving the parameter to the SD card and Storage for only saving the data to the SD card.
- 6) The sensor can compensate for variable Temperature, Conductivity and Pressure when installed on a SeaGuardII or SmartGuard Datalogger. If the Datalogger has these sensors connected, the DCPS5400 can be configured to take the input from these sensors to calculate Depth, Salinity, Density and Sound Speed. The calculated depth is also used when surface cell and surface referred columns are enabled. If only some of the sensors are present, the DCPS can also combine sensor inputs and settings to calculate the derived sound speed. See Chapter 3.5.5 through 3.5.9 for explanation of Parameter Input when connected to a SeaGuardII or SmartGuard Datalogger.
- 7) The accuracy of the estimated current speeds depends on a correct sound speed setting. The cell positioning also depends on the sound speed. The best way to compensate for variable sound speed is described above in.

1.7.4 User Maintenance

This group contains sensor settings that normally are not altered by the user. To access most of these properties you need to send passkey(1000) or with Real-Time Collector use password: 1000. These properties are used to configure serial port settings, communication to and from sensor. If you got a wave license key you may also enable wave functionality, you may enter temperature coefficients if Temperature sensor is included, set limits for discarding ping if sensor tilt exceeds the limits and property to set the distance from pressure sensor port to centre of transducer elements.

Table 1-8: Sensor properties for Doppler Current Profiler Sensor 5400/5400R, 5402/5402R and 5403/5403R

ENUM=Enumeration, INT =Integer, BOOL=Boolean ('yes'/'no')

Table 1-1 Property	Type	No of elements	Use	Configuration Category	Access Protection Read/Write
<i>Node Description</i>	String	31	User text for describing node, placement etc.	UM	No / Low
<i>Owner</i>	String	31	User setting for owner information, company name etc.		No / High
<i>Interface</i>	String	31	Factory use only, RS232 for standard version, RS422 for R-version		High / High
<i>Baudrate</i>	ENUM	1	RS232 baudrate: 4800, 9600, 57600, or 115200. Default baudrate is 115200. The baudrate affects the minimum available Interval setting.		
<i>Flow Control</i>	ENUM	1	RS232/RS422 flow control: 'None' or 'Xon/Xoff'. The Xon/Xoff characters are also sent for each Doppler ping measurement. To remove the "disturbance" on the receiver, select None. Be aware that this may also lead to missing characters when sending commands to the sensor.		
<i>Enable Comm Indicator</i>	ENUM	1	Enable communication sleep ('%') and communication ready ('!') indicators. After the last communication with the sensor, it normally outputs a '%' when the <i>Comm Timeout</i> time is over. When a character is sent to the sensor, it outputs a '!' to indicate that it is ready to communicate.		
<i>Comm TimeOut</i>	BOOL	1	Time communication is active (Always On, 10 s, 20 s, 30 s, 1min, 2 min, 5 min, 10 min). A short time means that the sensor is going to sleep faster after a communication input.		
<i>Enable Old Time Setting</i>	BOOL	1	Enables old input in Smart Sensor Terminal mode for Interval and Polled pingrate.		
<i>Acoustic Wave Product Number</i>	String	6	For factory use only.		

<i>Acoustic Wave Option Key</i>	INT	8	To active the Wave features you need a license key. This key is delivered with the instrument or upgrade kit if wave is ordered. Only available in AiCaP.	UM	High / High
<i>Select Active Wave Cell</i>	INT	1	Select cell 1, 2 or 3 for calculation of wave, Cell 1 is closest to surface, default cell is 1. Only available in AiCaP.		
<i>Enable Fixed Wave Depth Cell</i>	BOOL	1	If enabled you might set the distance from surface to the centre of first wave cell in Wave Cell Center Depth. If not set the placement of first cell will be dynamic depending on wave measurement and depth. Only available in AiCaP.		
Wave Cell Center Depth	INT	1	Distance from surface to centre of first wave cell. Only available in AiCaP.		
<i>Enable Max Tilt Ping Discard</i>	BOOL	1	If enabled ping with tilt above limit will not be used.		
<i>Max Tilt Limit Ping Discard</i>	INT	1	Set the tilt limit in degrees for when to discard ping. Default value is 60.		
<i>Distance Pressure to Center TRD</i>	INT	1	Set the distance from pressure sensor reference port to centre of transducer, This value is used to instrument depth reference to the centre of transducer instead of pressure sensor port. Default value is 0.187 meter.		
<i>Temp Coeff</i>	INT	6	Only available if Temperature sensor 4080 is installed and calibrated.		

Doppler Current Profiler Sensor 5400/5402/5403 Specifications Refer Datasheet D 411 which is available on our web site <http://www.aanderaa.com> or contact aanderaa.info@xylem.com.

You will find the latest versions of our documents on Aanderaa website.

1.8 Manufacturing and Quality Control

Aanderaa Data Instruments products have a record for proven reliability. With over 50 years' experience producing instruments for use in demanding environments around the globe you can count on our reputation of delivering the most reliable products available.

We are an ISO 9001, ISO 14001 and OHSAS 18001 Certified Manufacturer. As a company we are guided by three underlying principles: quality, service, and commitment. We take these principles seriously, as they form the foundation upon which we provide lasting value to our customers.

CHAPTER 2 Stand-alone sensor configuration using AADI Real-Time Collector

This chapter describes the sensor configuration using AADI Real-Time Collector when the sensor is used as stand-alone sensor with serial communication RS-232 or RS-422 via the PC COM-port. The menus shown here are slightly different from the menus shown when the sensor is working in AiCaP mode and configured through an Aanderaa Datalogger via serial or USB connection to the PC (described in CHAPTER 3). It's also possible to use terminal software to configure a stand-alone sensor, refer CHAPTER 5, but then you need to enter all the commands and send them to the sensor. With Real-Time collector it's much easier since the software will then let you configure the sensor using the available choices in each category. Before connecting the sensor you need to install and start the AADI Real-Time Collector software on your PC (provided on memory stick delivered with the instrument). If using windows 10 please see [chapter 11.1](#)

For more information about the AADI Real-Time Collector, refer TD 268 AADI Real-Time Collector Operating Manual.

2.1 Establishing a new connection

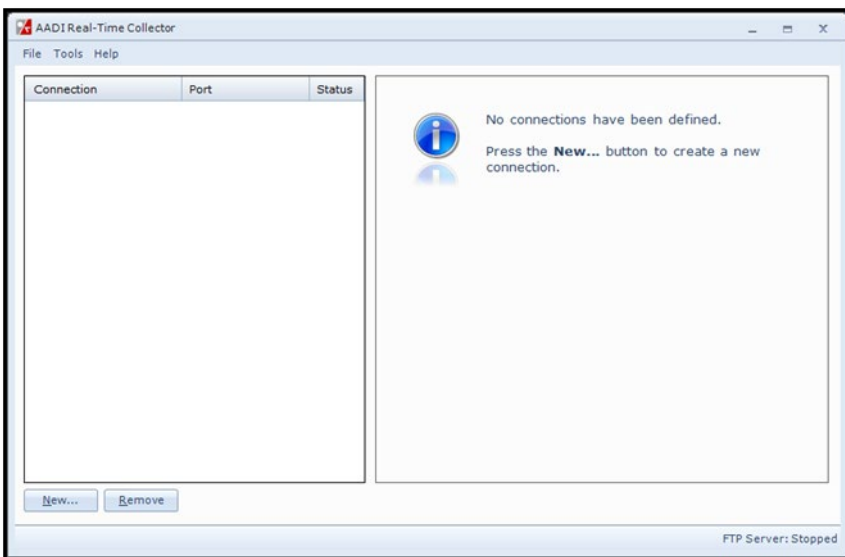

If the AADI Real-Time Collector program is being used for the first time, the connection list will be empty. Click on the **New** button in the lower left corner to create a new connection (refer [Figure 2-1](#)).

NOTE: This only needs to be done once. AADI Real-Time Collector will keep the information for later use and next time you might select it from the connection list.

Figure 2-1: AADI Real-Time Collector start up menu

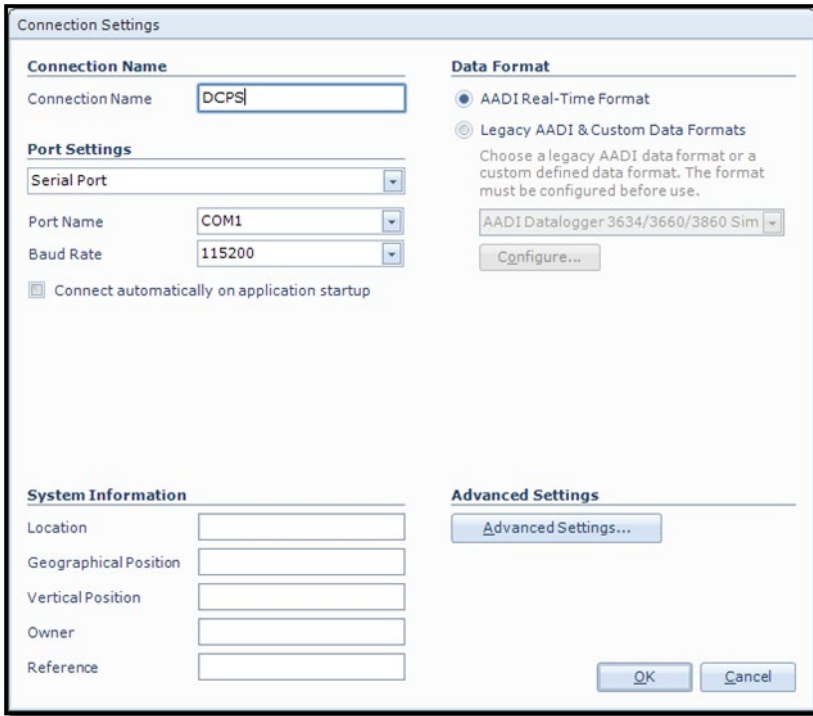

Refer **Figure 2-2**. First enter a new **Connection Name**, we recommend using name and serial number. Select **Serial Port** in the dropdown menu under **Port Setting**, and choose the correct COM-port on your computer under **Port Name**. Select **115200** as **Baud Rate**. This is the default baud rate on all DCPS sensors. The **Baud Rate** needs to match the baud rate set in **User Maintenance**.

Figure 2-2: AADI Real Time Collector connection settings

Click on the **Advanced Settings** in the right lower corner and select **Connection** on the left side in the **next** window as shown below.

The **Advanced Settings** are only accessible to change when the port is closed. If the settings are grey then you first need to close the port, refer **Figure 2-4 Open Port / Close Port**.

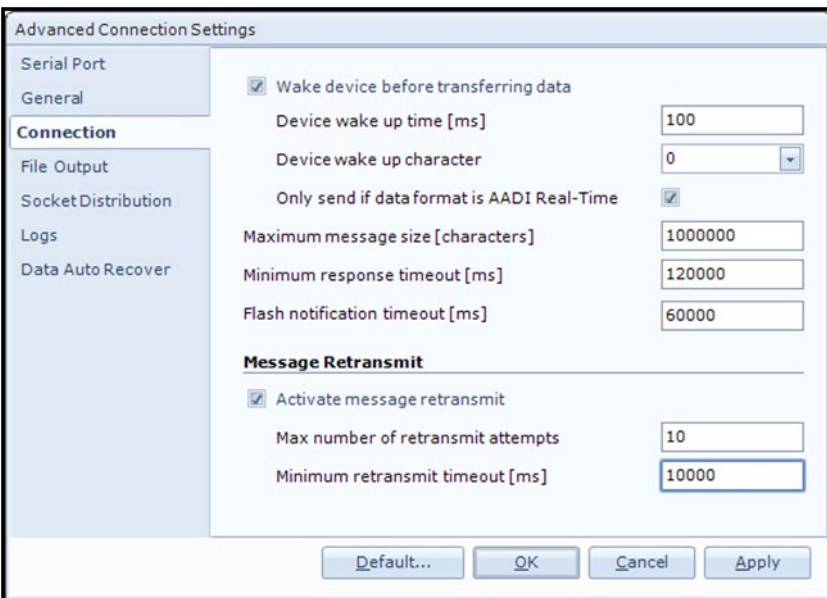

Refer to **Figure 2-3**: AADI Real-Time Collector uses a default setting that fits for most Smart Sensor. However the DCPS sensor outputs a large amount of data and might have much longer response time (depending on the configuration) than other smart sensors. Some of the connection settings might need to be changed. We recommend using the settings as shown in **Figure 2-3**.

After updating the **Advanced Connection Settings**, click on **Apply** and **OK** and then **OK** to go back to the start screen.

Figure 2-3: Advanced connection setting

2.1.1 Establish connection

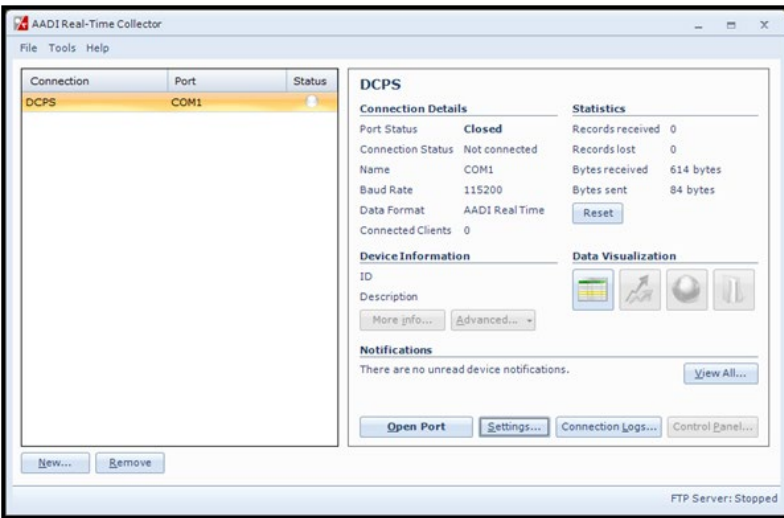

The new connection is now shown in the AADI Real-Time Collector connection list. Click on the line with the new connection to highlight the line and then click on the **Open Port** button.

Figure 2-4: New connection

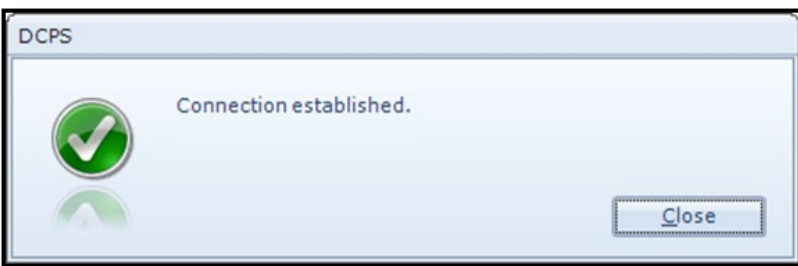

When the connection is established a small window will show up confirming the connection

Figure 2-5: Connection established

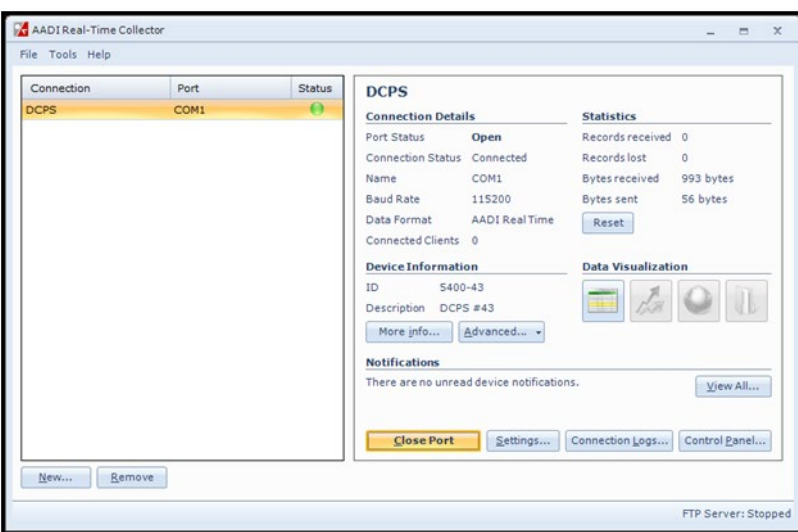

The status changes to green when the port is opened. After green light is obtained click on the **Control Panel** button on the lower right side to continue.

Figure 2-6: Green Status

2.1.2 Control Panel

In the **Control Panel** window you will find two tabs, **Recorder Panel** and **Device Configuration**. Under **Recorder Panel** you can start and stop recordings. If the recorder is running first click on the **Stop Recorder** as you are not allowed to configure the sensor when recording. The recorder panel is dependent on the Sensor Mode. In **AADI Real-Time** mode you may start and stop the recorder. For **AiCaP** and **Smart Sensor Terminal** you can only refresh the status but not start the recording.

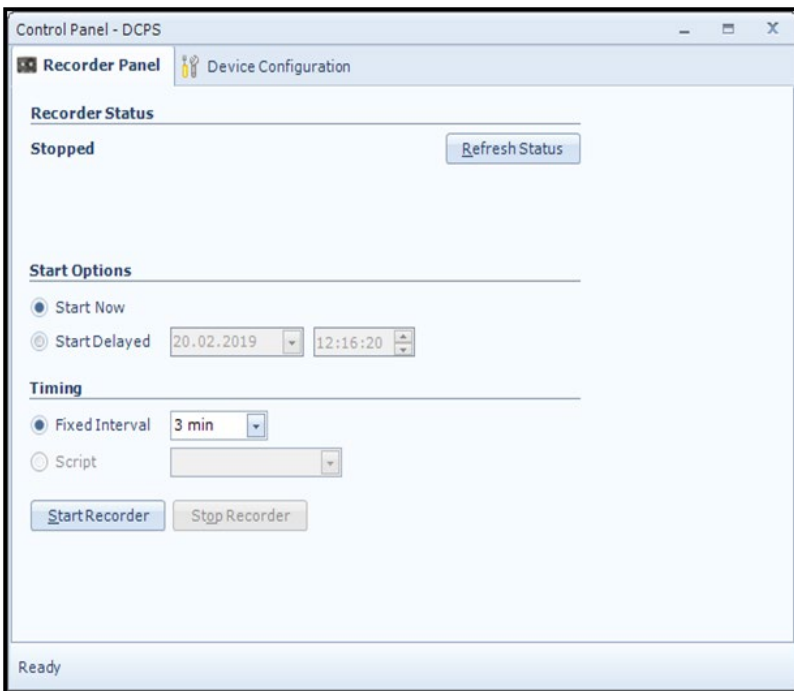

Figure 2-7: Recorder Panel

Under **Start Option** you can start sensor immediately by **Start Now**. The **Start Delayed** option is not yet implemented.

In the **Timing** session you may select the recording interval using **Fixed Interval**. The available interval will be dependent on the sensor configuration. If you change the configuration it might cause a change in the **Fixed Interval** so we recommend always checking the interval after configuration is finished.

The **Script** is not yet implemented.

The sensor will output one recording every interval.

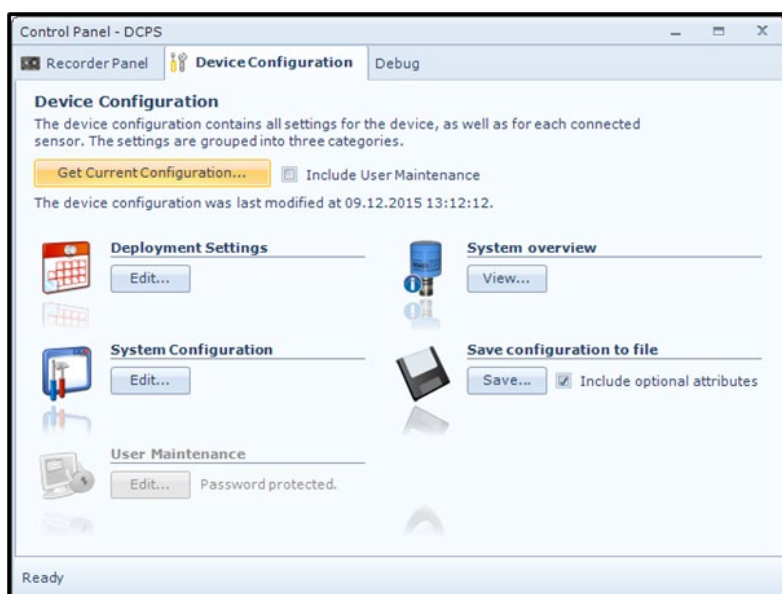

Figure 2-8: Device configuration

Click on the **Device Configuration** tab to continue and access the sensor property menus.

Under the **Device Configuration** tab click on the **Get Current Configuration...** button in order to receive the current configuration from the sensor.

To include the **User Maintenance** settings tick off the **Include User Maintenance** box before clicking the **Get Current Configuration...** button.

The settings in **User Maintenance** are protected with a higher access level. To access this menu you will need to enter a **password**. This **password is 1000** for all sensors.

The device configuration is separated into **Deployment settings**, **System Configuration**, **User Maintenance**, **System overview** and **Save configuration to file**.

You can save current settings to a backup file by pressing **Save...** under the heading **Save configuration to file**. Edit the name for your file and press **Save...** to save the new configuration to file in .xml format.

System overview shows a short list of sensor properties like product name, serial number and Software version.

User accessible sensor properties are found in **Deployment settings**, **System Configuration** and **User Maintenance**. Refer **Table 1-5** to **Table 1-8** for an overview of the properties.

Note! The screen shots might show minor discrepancies compared to screen shots taken from your sensor due to sensor updates.

Note! We recommend that you verify the system settings prior to starting a recording session.

2.2 Changing Values

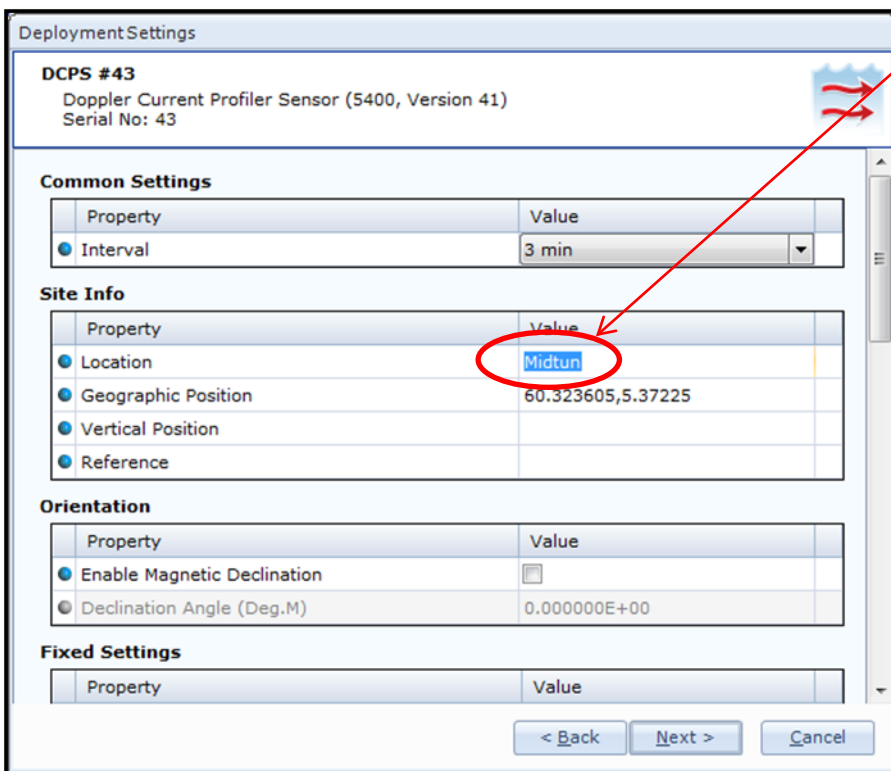

To change the content of a property first tick in the value box of the actual property and then enter the text or number before pressing **Next**.

See example in **Figure 2-9** where the text for **Location** has been changed.

The value is not changed before you have finished the full process. If you press **Cancel** the changes will not be stored.

Figure 2-9 Change value

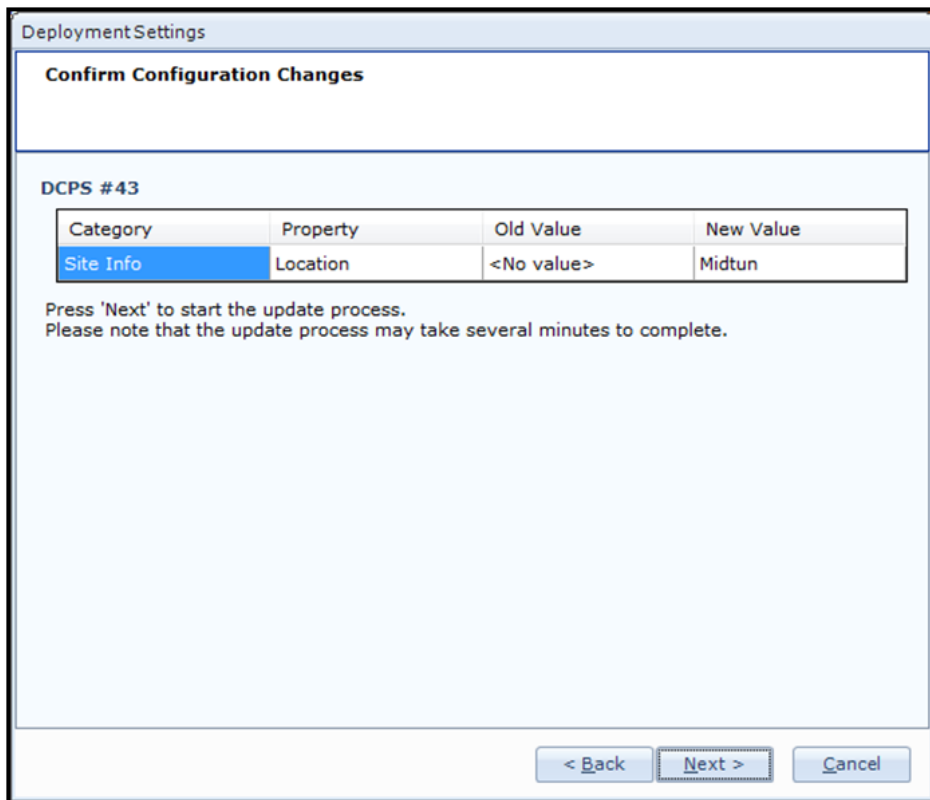

In the next picture a list of all properties that has been changed will show up.

If the list of configuration changes is correct press **Next** to start the update process.

Figure 2-10 Confirm Configuration Changes

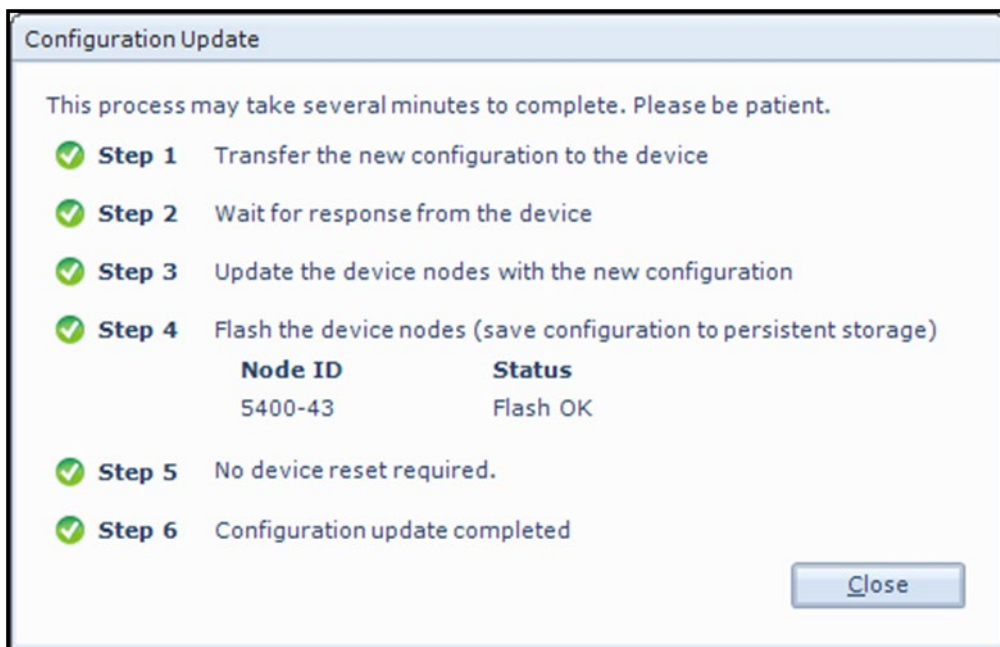

An automatic process will start with 6 steps transferring and storing the new information/setting in the sensor Flash. If necessary a reset will be executed. Do not switch off before the entire process is completed.

Figure 2-11 Configuration Update

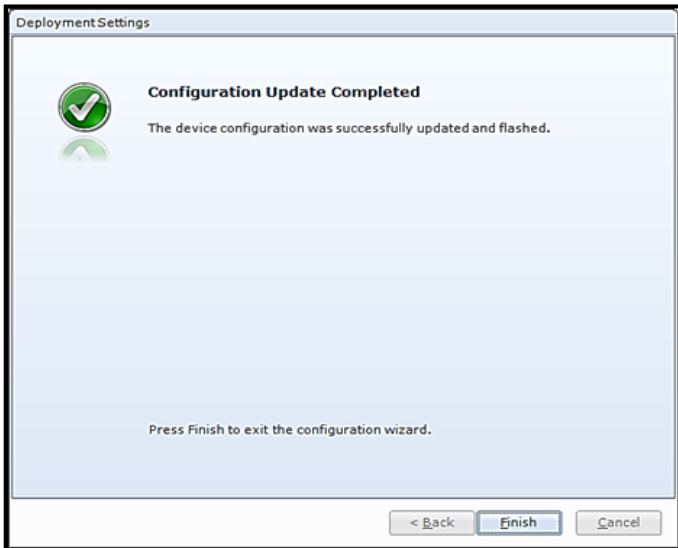

When the updating process is finished a confirmation will show up. Press **Finish** to continue.

Figure 2-12 Configuration Update Completed

2.3 Deployment Settings

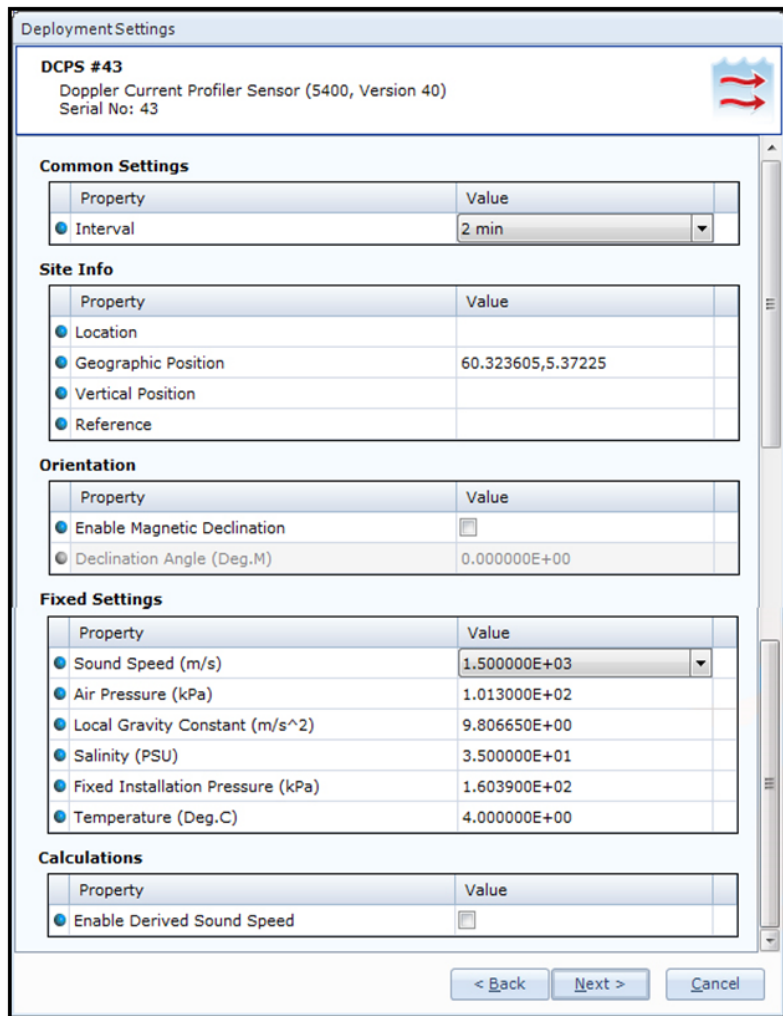

The **Deployment Settings** is separated in 5 groups. The settings in this groups are mainly used as information or values used in internal calculations.

Refer chapter 1.7.2 for more information on the properties in **Deployment Settings**.

When used as a stand-alone sensor without AiCaP Datalogger the fixed settings are used for calculations.

If the surface cell is enabled or the surface reference is enabled, this means that it uses the depth calculated from these fixed settings given in the **Deployment Settings**.

NOTE! We don't recommend using surface cell or surface referenced cell if no pressure sensor is used and connected via AiCaP.

In AiCaP mode more settings are available. See chapter 3.5

For more information on each property see chapter 2.3.1 to 2.3.5

Figure 2-13: Deployment Settings

2.3.1 Common Settings

Common Settings	
Property	Value
<input checked="" type="radio"/> Interval	2 min

Figure 2-14: Common Settings

The interval can be changed in the **Deployment Settings** but can also be defined in the Control Panel in the **Recorder Panel** before starting the sensor. It can be changed here also if for example the sensor is going to be used without Real-Time Collector to collect data while running.

2.3.2 Site Info

Site Info	
Property	Value
<input checked="" type="radio"/> Location	
<input checked="" type="radio"/> Geographic Position	60.323605,5.37225
<input checked="" type="radio"/> Vertical Position	
<input checked="" type="radio"/> Reference	

Figure 2-15: Site Info

Site Info containing four properties:

- **Location**
- **Geographic Position**
- **Vertical Position**
- **Reference**

All these settings are optional information to be entered to store information about the deployment. These setting are not used in calculation. **Geographical Position** is used to give the map coordinates unless a GPS input is connected to the logger

2.3.3 Orientation

Orientation	
Property	Value
<input checked="" type="radio"/> Enable Magnetic Declination	<input type="checkbox"/>
<input type="radio"/> Declination Angle (Deg.M)	0.000000E+00

Figure 2-16: Orientation

Enable Magnetic Declination is normally used when sensor is used close to South Pole or North Pole. **Declination Angle (Deg.M)** is a value to correct for the magnetic variation on the site where the sensor is used. This is the angle in degrees between magnetic north and true north. Magnetic declination (variation) is the angle between the magnetic north and the true north. This angle varies depending on the position on the Earth’s surface and also varies over time. Declination is positive when magnetic north is east of true north and negative when it is to the west (input angle value $\pm 180^\circ$). Magnetic declination at the deployment location can be found for i.e. on NOAA website:

<http://www.ngdc.noaa.gov/geomag-web/>

2.3.4 Fixed Settings

Fixed Settings	
Property	Value
● Sound Speed (m/s)	1.500000E+03
● Air Pressure (kPa)	1.013000E+02
● Local Gravity Constant (m/s ²)	9.806650E+00
● Salinity (PSU)	3.500000E+01
● Fixed Installation Pressure (kPa)	1.603900E+02
● Temperature (Deg.C)	4.000000E+00

Figure 2-17: Fixed Settings

Fixed Settings as shown in Figure 2-17 are settings used in internal calculation.

Sound Speed (m/s) is the fixed sound speed setting in m/s. This value is used for cell positioning in the profile and for calculation of current speed values. Variable sound speed values can be used while sensor is running in Smart Sensor Terminal mode. Default value for sea water is 1500.

Air Pressure (kPa) is the barometric pressure in kPa used to compensate for air pressure. The default value is 101.3

Local Gravity Constant (m/s²) is the local gravity constant in m/s². The default value is 9.81m/s²

Salinity (PSU) is the Salinity in PSU used for calculation of density, sound speed and depth. The value can be altered while sensor is running in Smart Sensor Terminal mode to compensate for variable salinity.

Fixed Installation Pressure (kPa) is the pressure in kPa at the deployment site. The value can be altered while sensor is running to compensate for variable pressure. NOTE! This value is used for calculation of and used to position cells referenced to surface if surface cell or surface referenced cell are selected

Temperature (Deg.C) is the temperature in degree centigrade. The value is used for calculation of Salinity, Sound speed and Density. The value can be altered while sensor is running in Smart Sensor Terminal mode to compensate for variable temperature.

2.3.5 Calculations



Calculations	
Property	Value
<input checked="" type="checkbox"/> Enable Derived Sound Speed	<input type="checkbox"/>

Figure 2-18: Calculations

Under **Calculations** you find only one Property, **Enable Derived Sound Speed**. If enabled the sound speed will be calculated from the other available sensors (only in AiCaP mode) or by using fixed values. This overrides the Sound Speed setting. This is mainly used in AiCaP mode where data from sensors connected to the same AiCaP bus are available in real-time. If a parameter is available from another sensor it will use this in the calculation, otherwise it will use the fixed value.

2.4 System Configuration

System Configuration

DCPS #43
 Doppler Current Profiler Sensor (5400, Version 46)
 Serial No: 43

Common Settings

Property	Value
Mode	Smart Sensor Terminal
Enable Sleep	<input checked="" type="checkbox"/>

Terminal Protocol

Property	Value
Enable Polled Mode	<input type="checkbox"/>
Polled Pingrate	1 Hz
Enable Text	<input checked="" type="checkbox"/>
Enable Decimalformat	<input type="checkbox"/>

Orientation

Property	Value
Enable Tilt Compensation	<input checked="" type="checkbox"/>
Enable Fixed Heading	<input type="checkbox"/>
Fixed Heading (Deg.M)	0.000000E+00
Enable Upside Down	<input type="checkbox"/>

Current Profile Measurement

Property	Value
Bandwidth	Broadband
Enable Ambiguity Lock	<input checked="" type="checkbox"/>
Ping Number	20
Enable Burst Mode	<input type="checkbox"/>
Burst Period Placement	End Of Interval

Surface

Property	Value
Enable Surface Cell	<input checked="" type="checkbox"/>
Surface Cell Size	1.0m

Column 1

Property	Value
C1 Enable Surface Reference	<input checked="" type="checkbox"/>
C1 Cell Size	1.0m
C1 Distance First Cell Center	3.0m
C1 Number Of Cells	15
C1 Cell Center Spacing	1.0m

Column 2

Property	Value
C2 Enable Column	<input checked="" type="checkbox"/>
C2 Enable Surface Reference	<input type="checkbox"/>
C2 Cell Size	1.0m
C2 Distance First Cell Center	3.0m
C2 Number Of Cells	50
C2 Cell Center Spacing	0.2m

The **System Configuration** is separated in 13 groups. The settings in these groups are mainly used to configure the sensor and control the output/ storage of data. Refer chapter 1.7.3 for more information on the properties in **System Configuration**.

If you change mode you might need to go back to the Recorder panel and **Refresh Status** and or **Stop Recorder** before you can continue to configure.

The Mode setting will also influence some of the alternatives in the rest of the session.

For more information on each property see chapter 2.4.1 to 2.4.13.

Figure 2-19: System Configuration, part 1

Column 3

Property	Value
<input checked="" type="radio"/> C3 Enable Column	<input type="checkbox"/>
<input checked="" type="radio"/> C3 Enable Surface Reference	<input type="checkbox"/>
<input checked="" type="radio"/> C3 Cell Size	2.0m ▼
<input checked="" type="radio"/> C3 Distance First Cell	2.0m ▼
<input checked="" type="radio"/> C3 Number Of Cells	10 ▼
<input checked="" type="radio"/> C3 Cell Center Spacing	2.0m ▼

Output - Profile Parameters

Property	Value
<input checked="" type="radio"/> Select Profile Parameters	Simple Output ▼
<input checked="" type="radio"/> Enable 4-Beam Auto Replacement	<input type="checkbox"/>

User Specified - Profile Parameters

Property	Value
<input checked="" type="radio"/> NE Speed Output	Output ▼
<input checked="" type="radio"/> 3-Beam Combination Output	Output ▼
<input checked="" type="radio"/> AutoBeam Output	Output ▼
<input checked="" type="radio"/> AutoBeam Speed Type	Rectangular ▼
<input checked="" type="radio"/> Vertical Speed Output	Output ▼
<input checked="" type="radio"/> Strength Output	Output ▼
<input checked="" type="radio"/> Beam Speed Output	Output ▼
<input checked="" type="radio"/> Beam Strength Output	Output ▼
<input checked="" type="radio"/> Std Dev Speed Output	Output ▼
<input checked="" type="radio"/> Std Dev Beam Speed Output	Output ▼
<input checked="" type="radio"/> Cross Difference Output	Output ▼
<input checked="" type="radio"/> Correlation Factor Output	Output ▼
<input checked="" type="radio"/> Noise Level Output	Output ▼

Output - Sensor Parameters

Property	Value
<input checked="" type="radio"/> Heading Output	Output ▼
<input checked="" type="radio"/> Pitch Roll Output	Output ▼
<input checked="" type="radio"/> Abs Tilt Output	Output ▼
<input checked="" type="radio"/> Max Tilt Output	Output ▼
<input checked="" type="radio"/> Tilt Direction Output	Output ▼
<input checked="" type="radio"/> Std Dev Heading Output	Output ▼
<input checked="" type="radio"/> Std Dev Tilt Output	Output ▼

Output - System Parameters

Property	Value
<input checked="" type="radio"/> Charge Voltage Output	Output ▼
<input checked="" type="radio"/> Memory Used Output	Output ▼
<input checked="" type="radio"/> Voltage Output	Output ▼
<input checked="" type="radio"/> Current Output	Output ▼
<input checked="" type="radio"/> Air Detect Output	Output ▼

Output - Virtual Sensors

Property	Value
<input checked="" type="radio"/> Speed Of Sound Output	Off ▼
<input checked="" type="radio"/> Depth Output	Off ▼
<input checked="" type="radio"/> Salinity Output	Off ▼
<input checked="" type="radio"/> Density Output	Off ▼

In the second half of the **System Configuration** menu you will find mainly setting that will control the output

If **User Specified** is selected under “**Output – Profile Parameters>Select Profile Parameters**” then the individual selection in the next menu **User Specified – Profile Parameters** will be valid. For all other settings in **Select Profile Parameters** the selections of parameters in **User Specified – Profile Parameters** will be overruled.

NOTE!! **User Specified – Profile Parameters** are only valid when **Select Profile Parameter** is set to **User Specified**,

The selection for each property in these menus will also be dependent on the mode setting.

Figure 2-20: System Configuration, part 2

2.4.1 Common settings

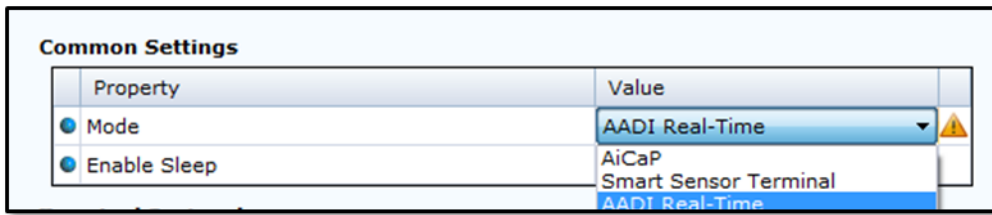

Figure 2-21: Common settings configuration

Refer to **Figure 2-21**: the communication protocol has to be defined under “**Mode**”. There are three different choices:

- **AADI Real-Time** is the correct mode (protocol) when used together with Real-Time Collector. This is an xml based protocol which includes more metadata in the data messages.
- The **Smart Sensor Terminal** protocol is a simplified protocol which is easier to use together with a PC terminal program. This protocol is described more detailed in CHAPTER 5. It is possible to configure the sensor even if it is set to **AiCaP** or **Smart Sensor Terminal** mode when it is connected via RS-232 to the PC, but it is not possible to run and log data with Real-Time Collector unless the sensor is set to **AADI Real-Time**. Notice that the sensor always has to be reset when the protocol/mode has been changed.
- If the sensor is going to be used on a SeaGuardII or SmartGuard Datalogger, the mode has to be changed to **AiCaP** mode first and saved before connecting it to the Datalogger.

2.4.2 Terminal Protocol settings

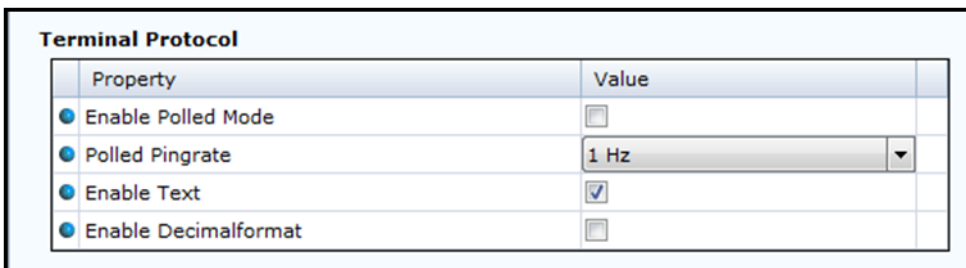

Figure 2-22: Smart Sensor Terminal protocol settings

The **Terminal Protocol** settings are available as shown in the **Figure 2-22** but are only used if the sensor is set to **Smart Sensor Terminal** protocol. See CHAPTER 5 for more details. This mode also opens up for a polled mode where the sensor is pinging on the selected ping rate and outputs data when the user/system polls for data by sending a **Do Sample()** command to the sensor. If **Enable Polled Mode** are set and **Polled Pingrate** 1Hz then the sensor will ping once every second and when the **Do Sample()** command are sent the sensor will use all ping since last **Do Sample()** to calculate all parameters.

Enable Text is used to switch on text information in the serial output from the sensor, only in **Smart Sensor Terminal** mode. Without text enabled the output string will be plain numbers for each output, see **Figure 5-3**.

Enable Decimalformat is used to either set decimal format or exponential format. Example of decimal format is 1023.45 and exponential format is 1.02345E+03.

2.4.3 Orientation settings

Orientation	
Property	Value
<input checked="" type="checkbox"/> Enable Tilt Compensation	<input checked="" type="checkbox"/>
<input checked="" type="checkbox"/> Enable Fixed Heading	<input type="checkbox"/>
<input type="checkbox"/> Fixed Heading (Deg.M)	0.000000E+00
<input checked="" type="checkbox"/> Enable Upside Down	<input type="checkbox"/>

Figure 2-23: Sensor orientation settings

Enable Tilt Compensation is recommended to set active at all time because then the sensor will automatically compensate for any tilt.

Enable Fixed Heading might be used if there is any magnetic disturbance that might interfere with a compass heading and the instrument has a fix position. Then Fixed Heading (Deg.M) can be used to set the offset between the Sensor North direction and the Magnetic North.

The upside down orientation setting should always be set the same way as the intended use; if the sensor is intended to be deployed upward looking, do not tick the **“Enable Upside Down”**. If the sensor is intended to be deployed downward looking, tick the **“Enable Upside Down”**.

However, the sensor will work even if the orientation setting is defined as the opposite of the used direction; it is able to sense the orientation itself and corrects the calculated current directions, heading etc. accordingly. **NB! The surface cell and surface reference of columns does not work if the sensor is orientated upside down while running (forced to be sensor referenced instead)**. A status flag in the record status output parameter is also set to indicate that the sensor has been used in the opposite direction to the configured direction.

2.4.4 Measurement settings

Current Profile Measurement	
Property	Value
<input checked="" type="checkbox"/> Bandwidth	Narrowband
<input checked="" type="checkbox"/> Enable Ambiguity Lock	<input checked="" type="checkbox"/>
<input checked="" type="checkbox"/> Ping Number	300
<input checked="" type="checkbox"/> Enable Burst Mode	<input checked="" type="checkbox"/>
<input checked="" type="checkbox"/> Burst Period Placement	Start Of Interval

Figure 2-24: Sensor measurement settings

The sensor can select between two **Bandwidths**, either **Narrowband** or **Broadband** to find the Doppler shift (and calculate the current parameters); see the DCPS Primer TD 310 for more details.

The two methods have their own advantages:

- **Broadband** gives a lower single ping standard deviation which requires fewer ping (lower energy usage) to get a good measurement result. The disadvantage in **Broadband** is ambiguity. If the sensor is fixed, for example when deployed in a bottom frame, the ambiguity is not a problem (ambiguity lock disabled). If it is moving and the user knows that the current speeds are always below 1 m/s, enable the ambiguity lock.
- If the sensor is moving (as under a buoy for example) and the current speeds are higher than 1 m/s, it is recommended to use **Narrowband**. Though **Narrowband** is more power consuming than **Broadband**, the reached measuring range is slightly longer than in **Broadband** mode.

Enable Ambiguity Lock is only used with **Broadband**. In **Broadband** the output of the correlation process is a phase value. When the Doppler shift is zero then the phase is also zero. When the Doppler shifts increase, so will the phase. A Doppler shifts of approximately 1.25 m/s along the beam corresponds to a phase equal to 360 (360 = 0) which is exactly the same as for zero Doppler shifts. For this reason the cross correlation process is not able to distinguish a Doppler shift of 1.5 from a Doppler shift of zero. In fact any Doppler shift outside the 1.25m/s range will be wrongly detected to be within the range 0 – 1.25 m/s. This is called ambiguity and could hamper the correct operation of the instrument if not corrected for. If ambiguity lock is enabled the result will stay in the first loop also between 0 and 1.25 m/s so if you know the current will be below 1.25 m/s you can use **Ambiguity Lock** and avoid any error caused by ambiguity,

In case the ambiguity lock is not selected, several stages of ambiguity solving methods are automatically implemented in the DCPS in order to achieve a non-ambiguous solution.

Ping Number is the number of ping transmitted during one recording interval. One ping is a transmitted pulse from all transducers. These four pulses are sent out simultaneously in four directions.

Enable Burst Mode. The sensor can run in burst mode or spread mode. When burst mode is enabled the sensor performs all ping measurements at the beginning or end of the recording interval, dependent on the Burst Period Placement setting. This can be set to either **Start Of Interval** or **End Of Interval**. If it is disabled the ping measurements are evenly spread out during the recording interval. The instrument activates sleep mode between each measurement, which reduces the power consumption. Power consumption in spread and burst mode is about the same. Refer **Figure 2-25**

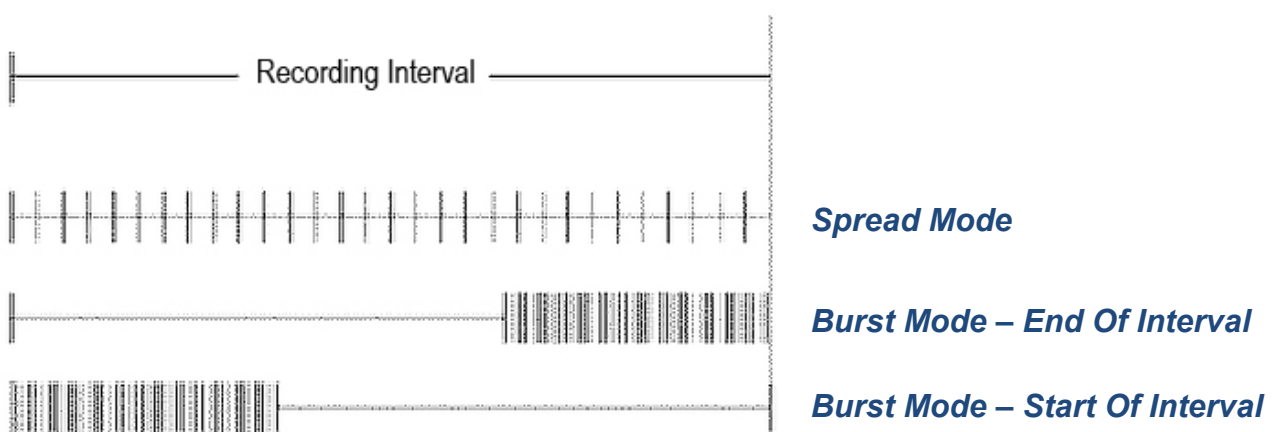

Figure 2-25: Spread mode and burst mode ping distribution during the recording interval

2.4.5 Surface settings – Configuration

Surface	
Property	Value
<input checked="" type="radio"/> Enable Surface Cell	<input type="checkbox"/>
<input type="radio"/> Surface Cell Size	2.0m

Figure 2-26: Surface cell configuration

Enable Surface Cell will set a cell in the surface layer. The data is set as not valid if the sensor is placed upside down with the surface cell enabled. **Surface Cell Size** or the measurement “window” is centred on the surface. At the surface, the impedance difference between the water and air creates an almost perfect reflector, and the acoustic signal is reflected by the surface. Regardless of the cell size used to process the surface cell, this cell will be dominated by the infinitesimal thin layer between water and air. Although the surface cell is infinitesimal small, the cell size used to process the data must be sufficiently large to capture the boundary between air/water defining the surface cell.

The surface cell will reflect the speed of the “boundary condition”. Wind will generate capillary waves, and rapidly accelerate the surface boundary. For this reason there will be a strong correlation between wind speed/surface boundary speed and wind direction / surface boundary direction.

NB! Do not use Surface Cell or Surface Reference together with Upside Down enabled, refer chapter 2.4.3.

The surface reference is ignored if the sensor is upside down while it is running (columns forced to be sensor referred).

If instrument is oriented Upside Down the surface cell is ignored and the data is set as non-valid.

2.4.6 Column 1

Column 1	
Property	Value
<input checked="" type="radio"/> C1 Enable Surface Reference	<input checked="" type="checkbox"/>
<input checked="" type="radio"/> C1 Cell Size	2.0m
<input checked="" type="radio"/> C1 Distance First Cell Center	3.0m
<input checked="" type="radio"/> C1 Number Of Cells	20
<input checked="" type="radio"/> C1 Cell Center Spacing	1.0m

Figure 2-27: Configuration of Column 1

The sensor does not have any depth measurement itself. In AiCaP mode when connected to a SmartGuard or SeaGuardII, the sensor can receive input from other sensors connected to the same datalogger such as pressure, tide and wave sensors. NOTE: this functionality is especially interesting when the deployment location shows some sea level variations as the tide. In this case the column will follow the surface variation but this is dependent on the input of pressure value. When used stand-alone be aware that you have to set correct fixed settings under **Deployment settings** if you want to use the **Surface Cell** or **Surface Reference** of columns. It is possible to update these fixed settings while the sensor is running (not possible through Real-Time Collector without stopping and starting the sensor again). If you are using a surface referred column with fixed settings, the results will not reflect the water level changes.

Column 1 is always active (not possible to disable). Column 1 can have up to 75 cells. Column 2 can have up to 50 cells and Column 3 can have up to 25 cells (150 cells all together). Columns 2 and 3 have to be enabled to be used.

C1 Enable Surface Reference: If set the cells will be referenced to the surface. The surface placement is measured by a pressure sensor prior to start of each recording interval. If not enabled the cells will be referenced to the transducers and located at certain distance from the transducer head.

C1 Cell Size: Whether the instrument is configured in broadband or narrowband, the user needs to configure the cell size (from 0.5 to 5m). The cell could be defined as the volume of water in which the instrument is performing the measurement. By defining the cell size, the number of cells, the cell centre spacing and knowing the speed of sound, the instrument determines the time frame when the reflected signal from the corresponding cell will be received.

C1 Distance First Cell Center: available range 1.5 to 70 meter. This will depend on the **C1 Enable Surface Reference** setting. If surface referenced it will be the distance from surface to centre of first cell. The minimum recommended distance will be the illegible zone, area not measured because of disturbance from side lobes, plus half the cell size. As a thumb of rules the illegible zone where signal is disturbed by side lobes is 10% of the deployment depth due to shorter distance to surface for the side lobs pointing upwards compared to the main lobs and the high reflection from the surface layer. The minimum distance to first cell centre should therefore be 10% of deployment depth plus half the cell size. If instrument referenced the minimum distance to first cell should be 1 meter blanking zone for 5400 and 2 meter for 5402 and 5403, plus half the cell size. This blanking zone is due to the fact that the instrument using the same transducers for transmitting the signal as used for receiving. For more information see Chapter 5 of TD 310 DCPS Theoretical Primer.

C1 Number OF Cells: Available from 1 to 75 cells. The instrument can measure multiple cells along the column from instrument to the maximum range given by the scatter condition, or from surface and down to the instrument dependent on the configuration.

C1 Cell Center Spacing is used to either obtain overlap between cells or spacing. If **Cell Center Spacing** is set to smaller than cell size the two following cells will overlap each other. This gives you higher resolution for the post processed data and makes it easier to locate special incidents like thermocline layers etc. If spacing is equal to cell size then two following cells will be adjacent to each other. If spacing is greater than cell size then there will be space between two following cells. This is useful if you want to measure only at certain depths for example 5, 15 and 25 meter from surface. To obtain this then set **Enable Surface Reference** enable, **Cell Size 2** meter, **Distance First Cell Center** 5 meter, **Number Of Cell 3** and **Cell Center Spacing** 10 meter.

2.4.7 Column 2

Column 2	
Property	Value
<input checked="" type="checkbox"/> C2 Enable Column	<input checked="" type="checkbox"/>
<input type="checkbox"/> C2 Enable Surface Reference	<input type="checkbox"/>
<input checked="" type="checkbox"/> C2 Cell Size	1.0m
<input checked="" type="checkbox"/> C2 Distance First Cell Center	3.0m
<input checked="" type="checkbox"/> C2 Number Of Cells	25
<input checked="" type="checkbox"/> C2 Cell Center Spacing	0.2m

Figure 2-28: Configuration of Column 2

C2 Enable Column: If you want more columns. The columns can be different, mix of both reference and configuration. Typical combination is one column covering the whole water column, one surface referenced with high resolution near surface and one instrument reference near bottom.

C2 Enable Surface Reference: Same as for C1 see chapter 2.4.6

C2 Cell Size: Same as for C1 see chapter 2.4.6

C2 Distance First Cell Center: Same as for C1 see chapter 2.4.6

C2 Number Of Cells: Available from 1 to 50 cells. The instrument can measure multiple cells along the column from instrument to the maximum range given by the scatter condition, or from surface and down to the instrument dependent on the configuration.

C2 Cell Center Spacing: Same as for C1 see chapter 2.4.6

2.4.8 Column 3

Column 3	
Property	Value
<input checked="" type="radio"/> C3 Enable Column	<input type="checkbox"/>
<input type="radio"/> C3 Enable Surface Reference	<input checked="" type="checkbox"/>
<input type="radio"/> C3 Cell Size	1.0m
<input type="radio"/> C3 Distance First Cell Center	3.0m
<input type="radio"/> C3 Number Of Cells	3
<input type="radio"/> C3 Cell Center Spacing	10.0m

Figure 2-29: Configuration of Column 3

C3 Enable Column: Same as for C2 see chapter 2.4.7

C3 Enable Surface Reference: Same as for C1 see chapter 2.4.6

C3 Cell Size: Same as for C1 see chapter 2.4.6

C3 Distance First Cell Center: Same as for C1 see chapter 2.4.6

C3 Number OF Cells: Available from 1 to 25 cells. The instrument can measure multiple cells along the column from instrument to the maximum range given by the scatter condition, or from surface and down to the instrument dependent on the configuration.

C3 Cell Center Spacing: Same as for C1 see chapter 2.4.6

2.4.9 Output enabling – Profile Parameters

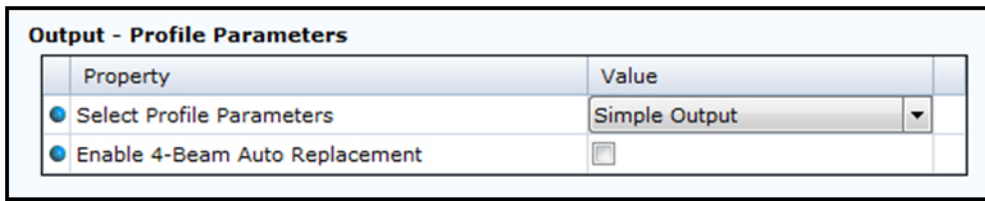

Figure 2-30: Output – Profile Parameters

While configuring the sensor, it is possible to define which parameters should be calculated and sent from the sensor.

Select Profile Parameters gives the user the choice to either select one of the predefined groups of Profile Parameter or you might select your own selection *in User Specified – Profile Parameters* refer chapter 2.4.10, by selecting **User Specified**. The sensor always outputs the **Cell State1**, **Cell State2**, **Horizontal Speed** and **Direction** for all the cells (not possible to disable). Available settings for **Select Profile Parameters** are:

- **Simple Output**
- **Basic Output**
- **Basic + Beam Output**
- **Basic + 3-Beam Output**
- **Basic + Beam + 3-Beam Output**
- **Full Output**
- **User Specified**

Refer **Table 2-1** for parameters included in each group.

Refer to **Table 1-5** for definition of the parameters.

NOTE: Enabling more data also means larger data messages and more time to transfer data.

All profile parameters are an average of each ping data from the last measurement interval.

Enable 4-Beam Auto Replacement. If selected all 4-beam parameters will automatically be replaced with the best 3-beam solution if a disturbance is detected in one of the beam.

Table 2-1: Profile Parameter additional parameters for each group

		Simple Output	Basic Output	Basic + Beam Output	Basic + 3-Beam Output	Basic + Beam + 3-Beam Output	Full Output
Profile parameter	Parameter name						
	Cell State 1	x	x	x	x	x	x
	Cell State 2	x	x	x	x	x	x
	Horizontal Speed	x	x	x	x	x	x
	Direction	x	x	x	x	x	x
NE Speed Output	North Speed		x	x	x	x	x
	East Speed		x	x	x	x	x
Vertical Speed Output	Vertical Speed		x	x	x	x	x
Std Dev Speed Output	SP Stdev Horizontal		x	x	x	x	x
Strength Output	Strength		x	x	x	x	x
Cross Difference Output	Cross Difference		x	x	x	x	x
Beam Speed Output	Beam1 Speed			x		x	x
	Beam2 Speed			x		x	x
	Beam3 Speed			x		x	x
	Beam4 Speed			x		x	x
Beam Strength Output	Beam1 Strength			x		x	x
	Beam2 Strength			x		x	x
	Beam3 Strength			x		x	x
	Beam4 Strength			x		x	x
Std Dev Beam Speed Output	Beam1 Stdev			x		x	x
	Beam2 Stdev			x		x	x
	Beam3 Stdev			x		x	x
	Beam4 Stdev			x		x	x
Correlation Factor Output in Broadband	Beam1 Correlation Factor			x		x	x
	Beam2 Correlation Factor			x		x	x
	Beam3 Correlation Factor			x		x	x
	Beam4 Correlation Factor			x		x	x
3-Beam Combination Output	SP Stdev Beam123				x	x	x
	SP Stdev Beam124				x	x	x
	SP Stdev Beam134				x	x	x
	SP Stdev Beam234				x	x	x
	North Beam123				x	x	x
	North Beam124				x	x	x
	North Beam134				x	x	x
	North Beam234				x	x	x
	East Beam123				x	x	x
	East Beam124				x	x	x
	East Beam134				x	x	x
	East Beam234				x	x	x

Continue.		Simple Output	Basic Output	Basic + Beam Output	Basic + 3-Beam Output	Basic + Beam + 3-Beam Output	Full Output
3-Beam Combination Output (continue)	Vertical Beam123				X	X	X
	Vertical Beam124				X	X	X
	Vertical Beam134				X	X	X
	Vertical Beam234				X	X	X
AutoBeam Output	SP Stdev AutoBeam						X
	Horizontal Speed AutoBeam						X
	Direction AutoBeam						X
	North AutoBeam						X
	East AutoBeam						X
	Vertical AutoBeam						X
	Point Parameters						
Noise Level Output	Noise Peak Level B1						X
	Noise Peak Level B2						X
	Noise Peak Level B3						X
	Noise Peak Level B4						X
	Noise Average Level B1						X
	Noise Average Level B2						X
	Noise Average Level B3						X
	Noise Average Level B4						X

2.4.10 User Specified settings – Profile Parameters

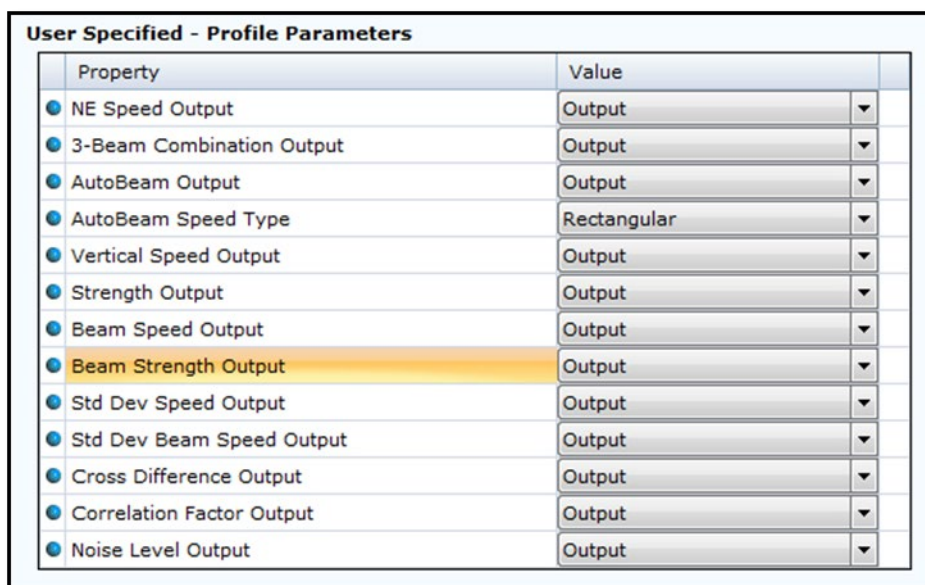

The **User Specified Profile Parameters** settings are settings that only are in use if **User Specified** is selected under **Select Profile Parameters**. For all other settings the group content displayed in **Table 2-1** will overrule the selection.

In stand-alone mode the alternatives are **Off** or **Output**

Figure 2-31: User Specified Profile Parameters

NE Speed Output outputs the calculated values for **North Speed** and **East Speed** where speed in north and east direction gives a positive value and speed in South and West direction gives a negative value.

3-Beam Combination Output outputs the four 3-Beam solutions, Beam 123, Beam 134, Beam 124 and Beam 234 for each of the four parameters, **SP Stdev Beam** (Single Ping Standard Deviation Beam), **North Beam**, **East Beam** and **Vertical Beam**. This information is useful if there is an obstruction in one of the beams but also important as quality control to decide that there is no disturbance in one or more beams.

AutoBeam Output outputs **SP Stdev AutoBeam** (Single Ping Standard Deviation AutoBeam), **Horizontal Speed**, **Direction**, **North**, **East** and **Vertical Speed** which for each parameter is the automatically selected best combination of either one of the 3-beam solutions or the 4-beam solution. If all five solutions are identical or close to identical the sensor will always select the 4-beam solution because this has more all beams pings and therefore better standard deviation.

AutoBeam Speed Type. If **AutoBeam Output** is selected then **AutoBeam Speed Type** will set the output type for these parameters. Alternative type is **Rectangular**, **Polar** or **Rectangular + Polar**. Where **Rectangular** is the direction in x,y coordinates and **Polar** is the direction referenced to Magnetic North.

Vertical Speed Output outputs the measured **Vertical Speed** based on the four beams. Alternatively 3 beams if **Enable 4-Beam Auto Replacement** is selected

Strength Output outputs an average of signal strength from the four transducers. Alternatively 3 transducers if **Enable 4-Beam Auto Replacement** is selected

Beam Speed Output outputs the individual speed measurements from each of the four beams

Beam Strength Output outputs the individual signal strength from each of the four beams.

Std Dev Speed Output outputs a calculated **SP Stdev Horizontal** (Single Ping Standard Deviation Horizontal Speed) based on measurements from the four beams. Alternatively three beams if **Enable 4-Beam Auto Replacement** is selected.

Std Dev Beam Speed Output outputs individual standard deviation for each beam.

Cross Difference Output outputs the Cross Difference which is the difference in Doppler shift from transducers on the same axis, for each depth the speed in beam 1 - speed beam 3 + speed beam 2 – speed beam 4 should be close to 0.

Correlation Factor Output outputs the correlation factor for each beam. The result should be close to 0.5. This setting is only for use in Broadband mode.

Noise Level Output outputs the **Noise Peak Level** and **Noise Average Level** for each of the four transducers. The noise level is a measurement done before the ping measurement where the sensor is only listening to the signal received by the transducers. **Noise Peak Level** outputs the highest signal level detected and this gives a good indication on nearby noise sources in the water (other current meters, echo sounders etc.)

2.4.11 Output enabling – Sensor Parameters

Output - Sensor Parameters	
Property	Value
● Heading Output	Output ▼
● Pitch Roll Output	Output ▼
● Abs Tilt Output	Output ▼
● Max Tilt Output	Output ▼
● Tilt Direction Output	Output ▼
● Std Dev Heading Output	Output ▼
● Std Dev Tilt Output	Output ▼

In this section sensor parameters related to the compass/tilt measurement are enabled or disabled.

Alternatively setting are either **Off** or **Output**.

Figure 2-32: Definition of output sensor parameters

A compass/tilt measurement is taken for each ping measurement (current speed measurement). One ping consists of one ping from each transducer. The given value is an average of all single measurements from the last measurement interval.

The Heading is the angle in degrees between transducer 1 and magnetic north. Turning the sensor clockwise gives an increasing angle. When looking at the sensor from the label side, transducer 1 is the transducer back to the left (refer to [Figure 9-1](#)). When looking at the sensor from the label side with the sensor upside down, transducer 1 is the transducer back to the right.

The tilt is converted to rotational angles, Pitch and Roll. The rotational angles are used internally when calculating correct heading from the 3D magnetic field vector and correct current speed components from the acoustic beam vectors in each cell. The Pitch and Roll output is an average from all measurements in the last measurement interval.

The Heading Output is the average compass reading referenced to north during one measurement interval.

Pitch Roll Outputs individually outputs **Pitch** and **Roll** as an average for one measurement interval.

Abs Tilt Output (Absolute tilt) is the tilt between the horizontal plane and the sensor’s plane. When upside down, the Abs tilt is varying around 180 degree. This is different from the Aanderaa RDCP (previous profiler generation). The new profiler is able to sense if it is upside down or not, and the absolute tilt indicates the actual direction of the sensor when it is running.

Max Tilt Output (Maximum tilt) is the highest abs tilt in any direction measured by the sensor during one measurement interval.

Tilt Direction Output is the average of all tilt direction measurement during one measurement interval.

Std Dev Heading Output (Standard Deviation Heading Output). The sensor does one heading measurement for each ping. This is the standard deviation of all the heading measurements during a recording interval.

Std Dev Tilt Output (Standard Deviation Tilt Output). The sensor does one tilt measurement for each ping. This is the standard deviation of all the absolute tilt measurements during a recording interval.

2.4.12 Output enabling – System Parameters

Output - System Parameters	
Property	Value
<input checked="" type="radio"/> Charge Voltage Output	Output ▼
<input checked="" type="radio"/> Memory Used Output	Output ▼
<input checked="" type="radio"/> Voltage Output	Output ▼
<input checked="" type="radio"/> Current Output	Output ▼
<input checked="" type="radio"/> Air Detect Output	Output ▼

The sensor can also output different system parameters like voltage, current draw while awake, and voltage to the acoustic transmitter circuits etc. that could be necessary during the QA&QC of data.

Figure 2-33: System parameter output selection

Charge Voltage Output is the charge voltage to the acoustic Tx circuits. This is important information to see if there is something wrong with the charge electronics or the transducers. Used for troubleshooting.

Memory Used Output gives a number for the used heap memory. Used for troubleshooting.

Voltage Output gives the measured input voltage internally in the sensor. This is a way to see if the input supply voltage starts dropping and also used to check power consumption. Value is dependent on type of battery or if external power is used.

Current Output is the measured input current to the sensor. This can indicate if something is wrong in the internal electronics if it suddenly starts to rise

Air Detect Output is the value measured by the air detects circuit. This is a circuit which detects if the sensor is in air or water

2.4.13 Output enabling – Virtual Sensors

Output - Virtual Sensors	
Property	Value
<input checked="" type="radio"/> Speed Of Sound Output	Output ▼
<input checked="" type="radio"/> Depth Output	Output ▼
<input checked="" type="radio"/> Salinity Output	Output ▼
<input checked="" type="radio"/> Density Output	Output ▼

The sensor can also calculate some virtual parameters. These are more interesting when the sensor is used on a Datalogger where the sensor can receive external sensor input via the Datalogger.

Figure 2-34: Virtual sensors output, additional calculated values

Speed Of Sound Output is the fixed or calculated Sound Of Speed setting.

Depth Output is the calculated depth based on fixed settings.

Salinity Output is the fixed salinity settings.

Density Output is the calculated density based on fixed settings.

2.5 User Maintenance settings

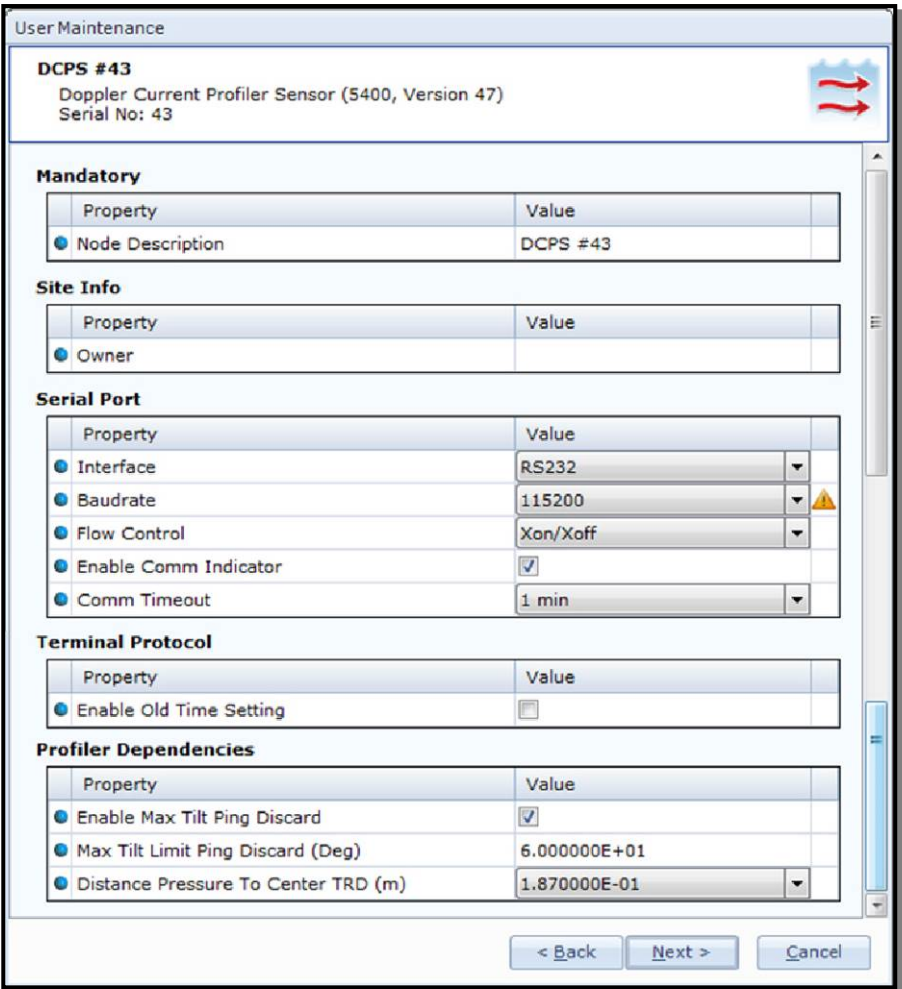

Under **User Maintenance**, you find properties that are password protected and are set / altered by a trained user. It is not recommended to change properties unless instructed. To access these, check the **“Include User Maintenance”** box in the device configuration before clicking on the **“Get Current Configuration...”** button. The password is: **1000**. The user maintenance settings are accessible by clicking the **“Edit...”** button under **User Maintenance** (refer to **Figure 2-8**).

Figure 2-35: User maintenance

2.5.1 Mandatory



Figure 2-36: Mandatory

All sensors are given a **Node Description** text like DCPS #xxx (xxx is the serial number of the sensor). The user can modify this node description text if required. Be aware that the node description changes to *Corrupt Configuration if it has lost the configuration in flash. Contact the factory if this happens. The configuration is saved in two sectors in flash memory. A flash sector can be corrupted if the power is lost during the saving of new configuration. The double flash sector saving ensures that it does not lose the configuration. If one of the sectors is corrupted, the other sector is used and also saved to the corrupt sector.

2.5.2 Site Info

Site Info	
Property	Value
Owner	

Figure 2-37: Site Info

Owner is only used for information and will be a part of the Meta data from the sensor. Not used in any calculations.

2.5.3 Serial Port

Serial Port	
Property	Value
Interface	RS232
Baudrate	115200
Flow Control	Xon/Xoff
Enable Comm Indicator	<input checked="" type="checkbox"/>
Comm Timeout	1 min

Interface is the interface between sensor and PC used for configuration. 5400, 5402 and 5403 are using RS-232 when 5400R, 5402R and 5403R are using RS-422. RS-422 sensors can be used with longer cables

Baudrate is the speed of communication via the serial port. The default setting from factory is 115200. If the sensor is going to be used on longer cables it may be necessary to lower the baud rate but then also the transmission time will increase

Flow Control is used to control the transmission speed between two units. Available settings are **None** and **Xon/Xoff**. Default setting is **Xon/Xoff**. The **Xon/Xoff** characters are also sent for each Doppler ping measurement. To remove the “disturbance” on the receiver, select **None**. Be aware that this may also lead to missing characters when sending commands to the sensor.

Enable Comm Indicator is enable communication sleep (%) and communication ready (!) indicators. After the last communication with the sensor, it normally outputs a '%' when the **Comm Timeout** time is over. When a character is sent to the sensor, it outputs a '!' to indicate that it is ready to communicate. If this setting is disabled the sensor will not send any indicators.

Comm Timeout is the time communication is active (Always On, 10 s, 20 s, 30 s, 1min, 2 min, 5 min, 10 min). A short time means that the sensor is going to sleep faster after a communication input.

2.5.4 Terminal Protocol

Terminal Protocol	
Property	Value
● Enable Old Time Setting	<input type="checkbox"/>

Figure 2-38: Terminal Protocol

Enable Old Time Setting. This setting enables old input in Smart Sensor Terminal mode for Interval and Polled pingrate.

2.5.5 Profiler Dependencies

Profiler Dependencies	
Property	Value
● Enable Max Tilt Ping Discard	<input checked="" type="checkbox"/>
● Max Tilt Limit Ping Discard (Deg)	6.000000E+01
● Distance Pressure To Center TRD (m)	1.870000E-01

Figure 2-39: Profiler Dependencies

Enable Max Tilt Ping Discard if this setting is enabled then if tilt exceeds the **Max Tilt Limit Ping Discard (Deg)** value the ping will not be used. This is used to avoid bad data from ping when the sensor is tilting too much.

Max Tilt Limit Ping Discard (Deg) is the value used to discard ping if **Enable Max Tilt Ping Discard** is enabled. Default value is 60 degrees.

Distance Pressure To Center TRD (m) is used to set the distance from pressure sensor inlet port (the reference level for the pressure sensor) to the centre of the DCPS transducers. Default value is 0.187 meter which is the distance when pressure sensor is mounted on the top-end plate underneath the DCPS.

CHAPTER 3 Configuration via SmartGuard or SeaGuardII Datalogger

3.1 Introduction

The Doppler Current Profiler Sensor 5400/5402/5403 can easily be installed on the Aanderaa SeaGuardII platform or connected using a cable. For more information about the SeaGuardII, refer to the TD 303, Operating manual SeaGuardII.

It can also be used with the SmartGuard Datalogger using a cable for surface buoy applications or placed on land.

To be able to control the DCPS via SeaGuardII or SmartGuard the sensor need to be in AiCaP mode.

3.2 Installation of the DCPS on SeaGuardII

Note! Mount DCPS on the stud and connect the stud in sensor position 1, refer *Figure 3-1*.

Always replace O-rings when connecting a sensor or a sealing plug.

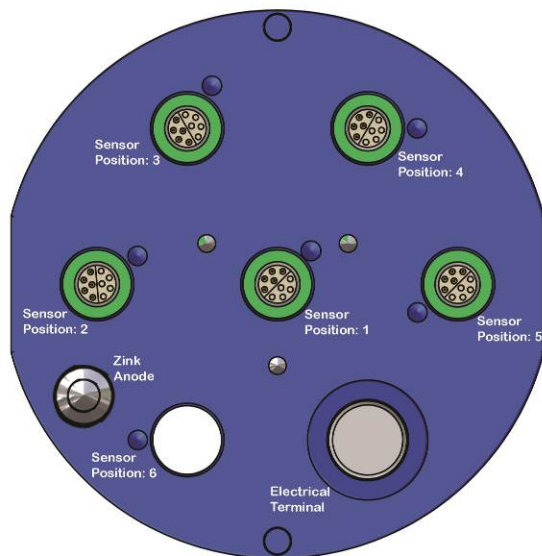

Figure 3-1: SeaGurdII Top End plate

Important!

Refer SeaGuardII Platform Operating Manual, TD 303 Chapter 7.4, for an illustrated sensor installation guide.

For more information on the settings related to the SeaGuardII, refer to the TD 303, manual for the SeaGuardII Platform Chapter 3.3.

3.3 Configuration with Real-Time collector

3.3.1 Connected via SeaGuardII

- Connect the micro USB configuration cable to the USB connector in front of the instrument and to the PC
- Install and start the AADI Real-Time Collector software on your PC (provided on the Memory stick delivered with the instrument). For more information about the AADI Real-Time Collector, refer TD 268 AADI Real-Time Collector Operating Manual
- Switch on the instrument by pressing the power button in the front of the instrument.
- Wait approximately 30 seconds before the instruments starts up and connection is established.

3.3.2 Connected via SmartGuard

- Connect the USB configuration cable to the USB connector on the left hand side of the SmartGuard and to the PC
- Install and start the AADI Real-Time Collector software on your PC (provided on the Memory stick delivered with the instrument). For more information about the AADI Real-Time Collector, refer TD 268 AADI Real-Time Collector Operating Manual
- Switch on the logger by turning the power to the “ON”- position.
- Wait approximately 30 seconds before the logger starts up and connection is established.

3.3.3 Establish connection

NOTE!

When using a USB connection, you also need to install Windows Mobile Device Center (Windows Vista, and Microsoft Windows 7) if not already installed on your computer. It can be downloaded from Microsoft website.

Windows Mobile Device Center acts as device management and data synchronization between a Windows Mobile-based device and a computer.

Once the USB connection has been established, Windows Mobile Device Center will start automatically:

If using windows 10 please see [chapter 11.1](#)



You may close this window after connection is established.

Figure 3-2: Windows Mobile Device Center

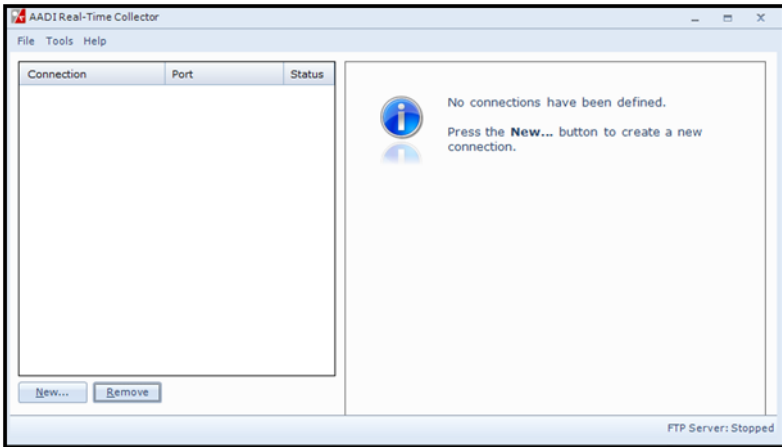

At first connection with AADI Real-Time Collector the connection list will be empty. Click on the **New** button in the lower left corner to create a new connection

NOTE: This only need to be done once. AADI Real-Time Collector will keep the information for later use and next time you might select it from the connection list.

Figure 3-3: AADI Real-Time Collector start up menu

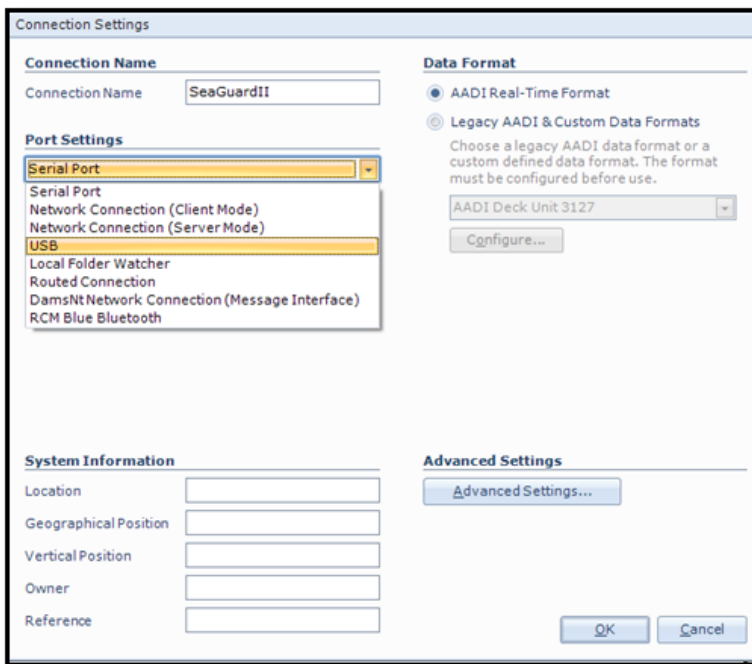

Select **USB** from the **Port Settings** drop down menu (Figure 3-4); and write a name in the **Connection Name** box (for i.e. SeaGuardII). We recommend using product name and serial number if you want to connect multiple instruments to the same software.

Figure 3-4: AADI Real time Collector connection settings

Click on the **Advanced Settings** in the right lower section and select **Connection** on the left side in the next window as shown below.

The **Advanced Settings** are only accessible to change when the port is closed. If the settings are grey then you first need to close the port, refer **Figure 3-6 Open Port / Close Port**.

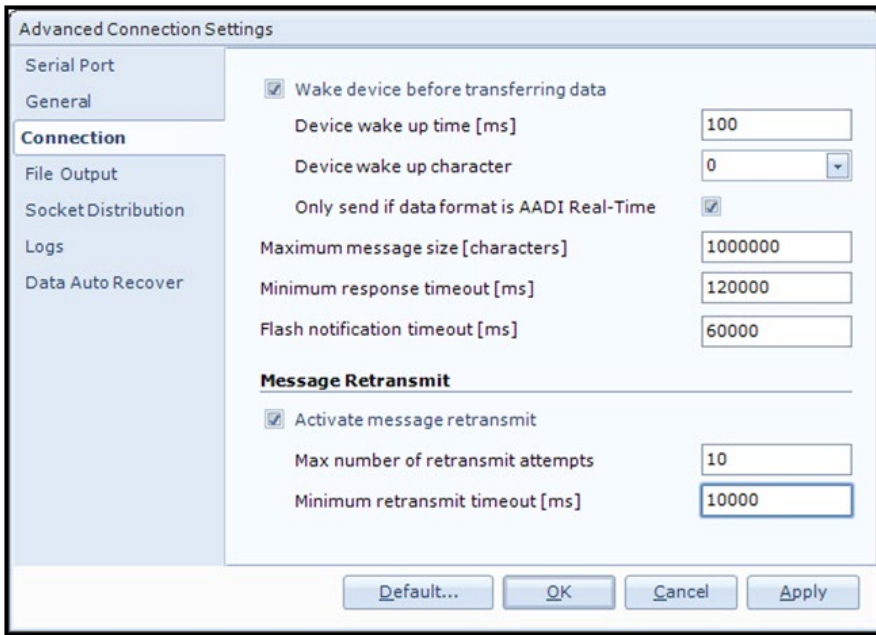

Figure 3-5: Advanced connection setting

Refer to **Figure 3-5**: AADI Real-Time Collector uses a default setting that fits for most Smart Sensor. However the DCPS sensor outputs a large amount of data and might have much longer response time (depending on the configuration) than other smart sensors. Some of the connection settings might need to be changed. We recommend using the settings as shown in **Figure 3-5**.

After updating the **Advanced Connection Settings**, click on **Apply** and **OK** and then **OK** to go back to the start screen.

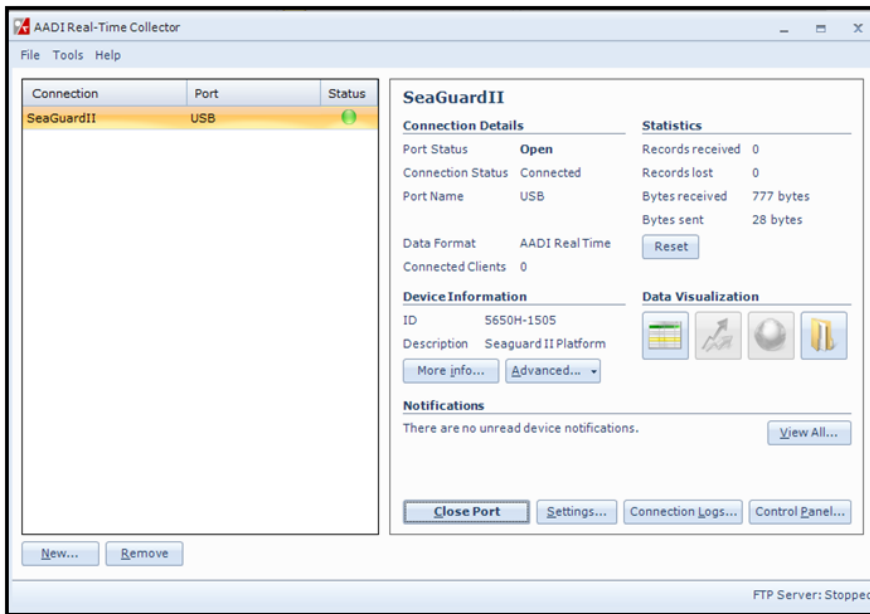

Figure 3-6: AADI Real-Time Collector main menu

Press **Open Port** and the connection to the SeaGuardII/SmartGuard should be established within a few seconds and the status turn to green. After power up it will take approximately 30 seconds before the logger is ready.

Open **Control Panel** in the lower right corner (refer **Figure 3-7**).

3.3.4 Control Panel

In the **Control Panel** window you will find four tabs, **Recorder Panel**, **Device Configuration Device Layout** and **System Status**. Under **Recorder Panel** you can start and stop recordings. If the recorder is running first click on the **Stop Recorder** as you are not allowed to configure the sensor when recording. For information about **Device Layout** and **System Status** see Manual for SeaGuardII Platform TD303 or SmartGuard TD293.

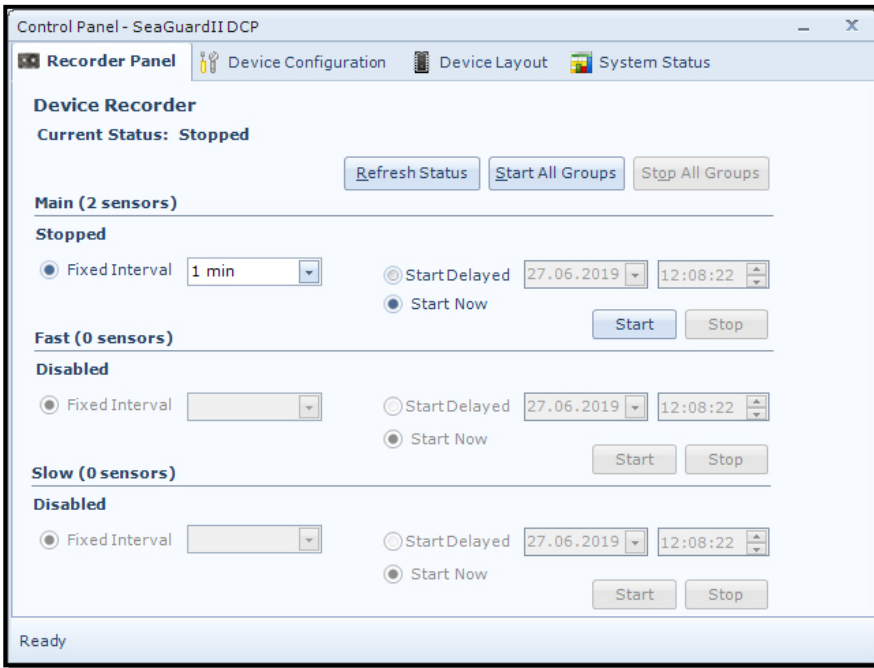

If the instrument is recording, under **Recorder Panel**, press “**Stop All Groups**”.

The **Control Panel** is controlling the SeaGuardII/SmartGuard recorder and not individual sensors. However the Recorder Panel consist of three recording groups where you might put individual sensors in each group to run them on different recording interval. See Operation Manual SeaGuardII / SmartGuard for more info.

Under each group you can start the group immediately by **Start Now**, or start at a later time using the **Start Delayed** option.

Figure 3-7: Recorder Panel

The **Fixed Interval** is the recording interval for each group. The configuration of sensors in each group will influence on the available recording interval. If you change the configuration of one sensor and this cause a longer processing time the **Fixed Interval** might be changed.

Each Sensor will do a calculation based on the configuration for each recording interval.

If Acoustic Wave is enabled then the recording interval for the group containing the DCPS will be the wave measurement period set by **Wave Integration Time** in the **System Configuration** setting, refer chapter 3.6.2 and the current measurement period.

One recording interval will then consist of a wave measurement period followed by one current measurement period. During the Wave measurement period only a reduced current measurement is calculated refer chapter 3.6.8. Other sensors in the same group will present one measurement during each recording interval.

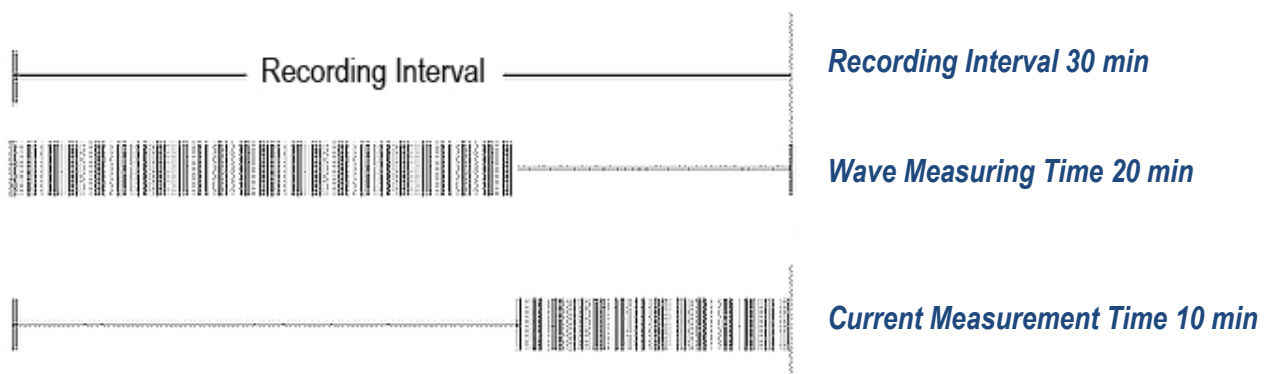
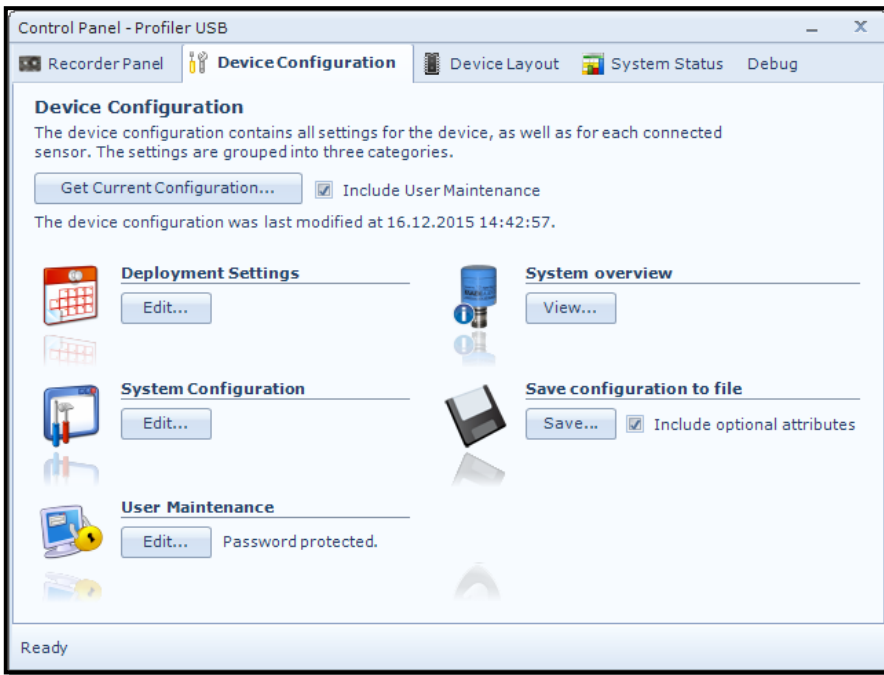

Figure 3-8: Typical Recording Interval Acoustic Wave and Current



The device configuration is separated into **Deployment settings, System Configuration, User Maintenance, System overview** and **Save configuration to file**.

Settings related to the DCPS can be configured under **Deployment Settings, System Configuration** and **User Maintenance**. **System overview** shows a short list of sensor properties like product name, serial number and Software version. Under the heading **Save configuration to file** you can save current settings to a backup file by pressing **Save...** Edit the name for your file and press **Save...** to save the new configuration to file in .xml format.

Figure 3-9: Device configuration

User accessible sensor properties are found in **Deployment settings, System Configuration** and **User Maintenance**. Refer **Table 1-5** to **Table 1-8** for an overview of the properties.

Note! The screen shots might show minor discrepancies compared to screen shots taken from your sensor due to sensor updates.

Note! We recommend that you verify the system settings prior to starting a recording session.

3.4 Changing Values

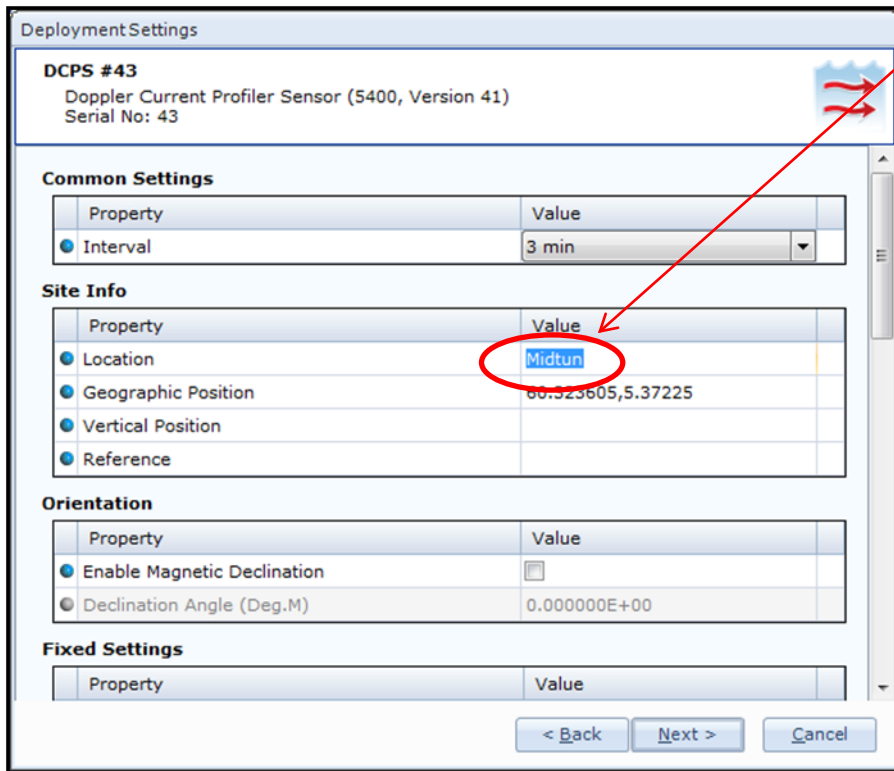

To change the content of a property first tick in the value box of the actual property and then enter the text or number before pressing **Next**.

See example in **Figure 3-10** where the text for **Location** has been changed.

Figure 3-10 Change value

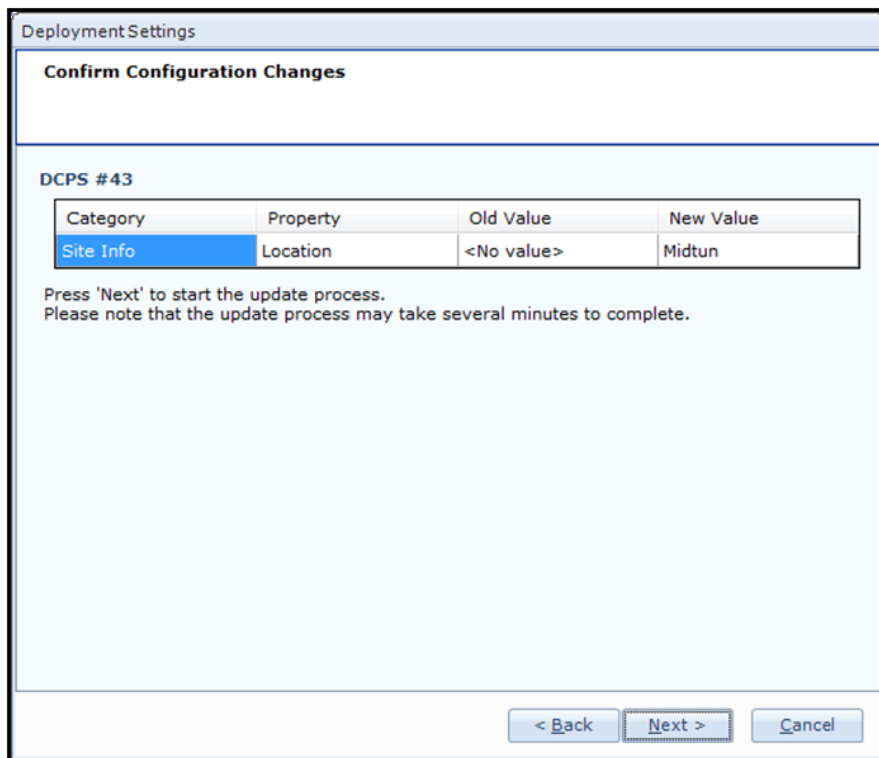

Then a list of all properties that has been changed will show up.

If the list of configuration changes is correct press **Next** to start the update process.

Figure 3-11 Confirm Configuration Changes

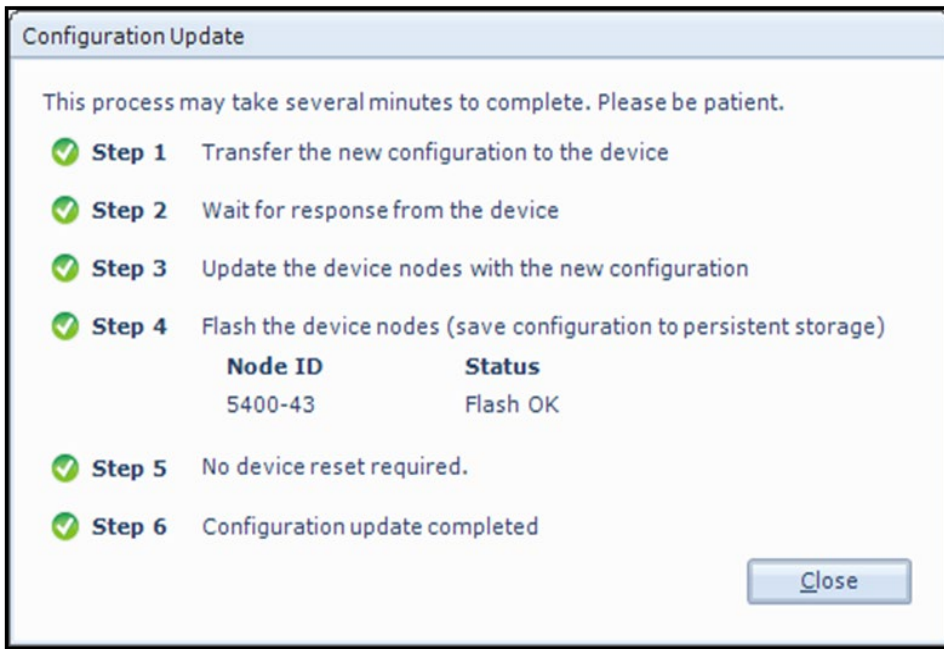

An automatic process will start with 6 steps transferring and storing the new information/setting in the sensor Flash. If necessary a reset will be executed. Do not switch off before the entire process is completed.

Figure 3-12 Configuration Update

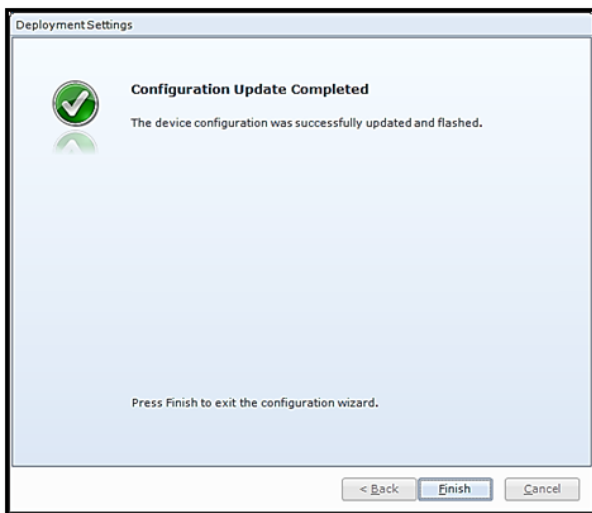

When the updating process is finished a confirmation will show up. Press **Finish** to continue.

Figure 3-13 Configuration Update Completed

3.5 Deployment settings

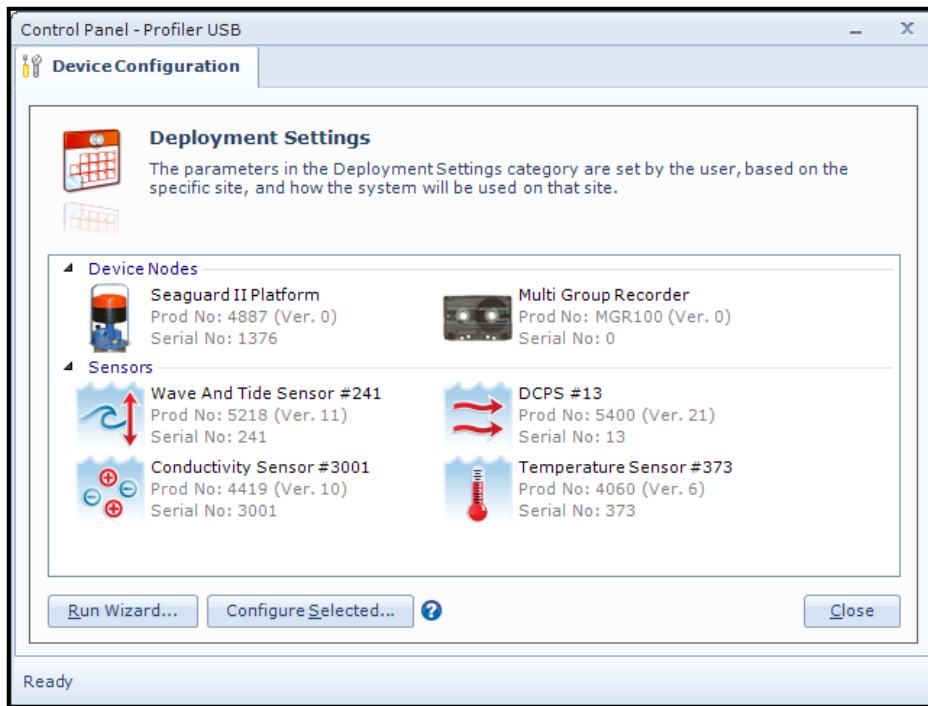

Select **Deployment Settings**.

Double-click on the **DCPS** to select the Doppler current profiler sensor (refer **Figure 3-14**)

If additional sensors are connected to the SeaGuardII platform, it is possible to configure the DCPS to take input from these other sensors. If pressure sensor and at least conductivity are available, it gives the possibility to get the correct sound speed and depth while the sensor is running.

Figure 3-14: Deployment settings

DCPS #43
 Doppler Current Profiler Sensor (5400, Version 47)
 Serial No: 43

Site Info

Property	Value
Location	Midtun
Geographic Position	60.323605,5.37225
Vertical Position	
Reference	

Orientation

Property	Value
Enable Magnetic Declination	<input type="checkbox"/>
Declination Angle (Deg.M)	0

Fixed Settings

Property	Value
Sound Speed (m/s)	1500.00
Air Pressure (kPa)	101.30
Local Gravity Constant (m/s ²)	9.807
Salinity (PSU)	35.000
Fixed Installation Pressure (kPa)	350.000
Temperature (Deg.C)	4.000

Calculations

Property	Value
Enable Derived Sound Speed	<input type="checkbox"/>

Input Parameter Pressure

Property	Value
Pressure Sensor Id	Pressure #962
Pressure Parameter Id	Not Selected

Input Parameter Air Pressure

Property	Value
Air Pressure Sensor Id	Not Selected
Air Pressure Parameter Id	Not Available

Input Parameter Temperature

Property	Value
Temperature Sensor Id	Not Selected
Temperature Parameter Id	Not Available

Input Parameter Conductivity

Property	Value
Conductivity Sensor Id	Not Selected
Conductivity Parameter Id	Not Available

Input Parameter Heading

Property	Value
Heading Sensor Id	Not Selected
Heading Parameter Id	Not Available
Heading Alignment Offset (Deg.M)	0.000

The **Deployment Settings** is separated in 9 groups. The settings in this groups are mainly used as information or values used in internal calculations. Refer chapter 1.7.2 for more information on the properties in **Deployment Settings**

If the surface cell, surface reference or acoustic wave is enabled, we always recommend using a pressure, tide or wave sensor.

A input parameter will be used in calculation if available and selected.

NOTE!
 Do not use the DCPS as an external reference, Input Parameter Sensor ID even if it is available in the list

For more information on each property see chapter 3.5.1 to 3.5.9.

Figure 3-15: Deployment Settings

3.5.1 Site Info

Site Info	
Property	Value
Location	Midtun
Geographic Position	60.323605,5.37225
Vertical Position	
Reference	

Figure 3-16: Site Info

Site Info containing four properties:

- **Location:** Name of location where the instrument is deployed.
- **Geographic Position:** GPS position for deployment format Latitude, Longitude.
- **Vertical Position:** Position in water column, e.g. 5 meter depth.
- **Reference:** Free text for additional information.

All these settings are optional information to be entered to store information about the deployment. These settings are not used in calculation. **Geographical Position** is used to give the map coordinates unless a GPS input is connected.

3.5.2 Orientation

Orientation	
Property	Value
Enable Magnetic Declination	<input type="checkbox"/>
Declination Angle (Deg.M)	0

Figure 3-17: Orientation

Enable Magnetic Declination is normally used when sensor is used close to South Pole or North Pole. **Declination Angle (Deg.M)** is a value to correct for the magnetic variation on the site where the sensor is used. This is the angle in degrees between magnetic north and true north. Magnetic declination (variation) is the angle between the magnetic north and the true north. This angle varies depending on the position on the Earth's surface and also varies over time. Declination is positive when magnetic north is east of true north and negative when it is to the west (input angle value $\pm 180^\circ$). Magnetic declination at the deployment location can be found for i.e. on NOAA website:

<http://www.ngdc.noaa.gov/geomag-web/>

3.5.3 Fixed Settings

Fixed Settings	
Property	Value
● Sound Speed (m/s)	1500.00
● Air Pressure (kPa)	101.30
● Local Gravity Constant (m/s ²)	9.807
● Salinity (PSU)	35.000
● Fixed Installation Pressure (kPa)	350.000
● Temperature (Deg.C)	4.000

Figure 3-18: Fixed Settings

Fixed Settings as shown in **Figure 3-18** are settings used in internal calculation.

Sound Speed (m/s) is the fixed sound speed setting in m/s. This value is used for cell positioning in the profile and for calculation of current speed values. Variable sound speed values can be used while sensor is running. Default value for sea water is 1500.

Air Pressure (kPa) is the barometric pressure in kPa used to compensate for air pressure. The default value is 101.3

Local Gravity Constant (m/s²) is the local gravity constant in m/s². The default value is 9.81m/s²

Salinity (PSU) is the Salinity in PSU used for calculation of density, sound speed and depth. The value can be altered while sensor is running to compensate for variable salinity.

Fixed Installation Pressure (kPa) is the pressure in kPa at the deployment site. The value can be altered while sensor is running to compensate for variable pressure. NOTE! This value is used for calculation of and used to position cells referenced to surface if surface cell or surface referenced cell are selected

Temperature (Deg.C) is the temperature in degree centigrade. The value is used for calculation of Salinity, Sound speed and Density. The value can be altered while sensor is running to compensate for variable temperature.

3.5.4 Calculations

Calculations	
Property	Value
● Enable Derived Sound Speed	<input type="checkbox"/>

Figure 3-19: Calculations

Under **Calculations** you find only one Property, **Enable Derived Sound Speed**. If enabled it will calculate the sound speed from the other available sensors or fixed values. This overrides the Sound Speed setting. If a parameter is available from another sensor it will use this in the calculation, otherwise it will use the fixed value.

3.5.5 Input Parameter Pressure

Input Parameter Pressure	
Property	Value
Pressure Sensor Id	Wave And Tide Sensor #241
Pressure Parameter Id	Tide Pressure(kPa)

Figure 3-20: External pressure sensor parameter input

Figure 3-20 gives an example of a wave & tide sensor connected to the Datalogger. The Wave and Tide sensor is selected as **Pressure Sensor Id** and the Tide Pressure is selected as **Pressure Parameter Id**. This enables the DCPS to calculate the depth dependent on this Tide Pressure input and other sensor input and/or the fixed settings. We recommend using the Tide as input if available.

3.5.6 Input Parameter Air Pressure

Input Parameter Air Pressure	
Property	Value
Air Pressure Sensor Id	Not Selected
Air Pressure Parameter Id	Not Available

Figure 3-21: External Air Pressure Parameter Input

Air Pressure Sensor Id gives a list of available air pressure sensor if connected. If connected then select the parameter under **Air Pressure Parameter Id**. Air Pressure is used to compensate for Air Pressure in calculations like absolute pressure and absolute tide. If no sensor is selected the fixed value will be used.

3.5.7 Input Parameter Temperature

Input Parameter Temperature	
Property	Value
Temperature Sensor Id	Temperature Sensor #373
Temperature Parameter Id	Temperature(Deg.C)

Figure 3-22: internal temperature sensor parameter input

Figure 3-22 gives an example of a temperature sensor connected to the Datalogger. The Temperature sensor is selected as **Temperature Sensor Id** and the Temperature(Deg.C) is selected as **Temperature Parameter Id**. The correct temperature is also necessary for calculation of the correct salinity and sound speed. If a temperature sensor is not connected, most of the other smart sensors also has a built in temperature sensor which can be selected from the drop-down list. We recommend using temperature from the sensor with fastest response time. The DCPS can also be delivered with its own temperature (optional); the temperature input has to be disabled here if the built-in temperature is going to be used.

If the DCPS is running in a slow recording group in the multi-group recorder (more information about the Multi-group recorder is available in the TD 303 Chapter 3.3.1), it is possible to have the other sensors in a faster group to give more frequent update of input parameters.

3.5.8 Input Parameter Conductivity

Input Parameter Conductivity	
Property	Value
● Conductivity Sensor Id	Conductivity Sensor #3001 ▼
● Conductivity Parameter Id	Conductivity(mS/cm) ▼

Figure 3-23: External conductivity sensor parameter input

Figure 3-23 gives an example of a conductivity sensor connected to the same Datalogger as the DCPS. The Conductivity sensor is selected as **Conductivity Sensor Id** and the Conductivity(mS/cm) is selected as **Conductivity Parameter Id**.

When the DCPS receives input from these three sensors via the Datalogger, it is able to calculate the correct salinity, depth and sound speed. These values are used for correct positioning of cells and the correct conversion from Doppler shift to current speeds.

3.5.9 Input Parameter Heading

Input Parameter Heading	
Property	Value
● Heading Sensor Id	Not Selected ▼
● Heading Parameter Id	Not Available ▼
● Heading Alignment Offset (Deg.M)	0.000

Figure 3-24: External compass sensor input

The sensor can also take an input from an external Compass, like for example the Airmar H2183 Compass. Surface buoys are often made of steel. The magnetic influence from the buoy can give a big error on the compass heading measured by the DCPS. A compass mounted on a mast away from the buoy structure is often a better method which gives a more accurate compass measurement. Select a compass connected to the Logger in the **Heading Sensor Id** drop-down menu if available and the heading parameter in **Heading Parameter Id**. The **Heading Alignment Offset (Deg.M)** value can be set to compensate for the misalignment between the compass axes and the axes on the DCPS.

When finished with the configuration, click **Next** twice and wait for the Datalogger to finish the saving of the new configuration.

3.6 System Configuration

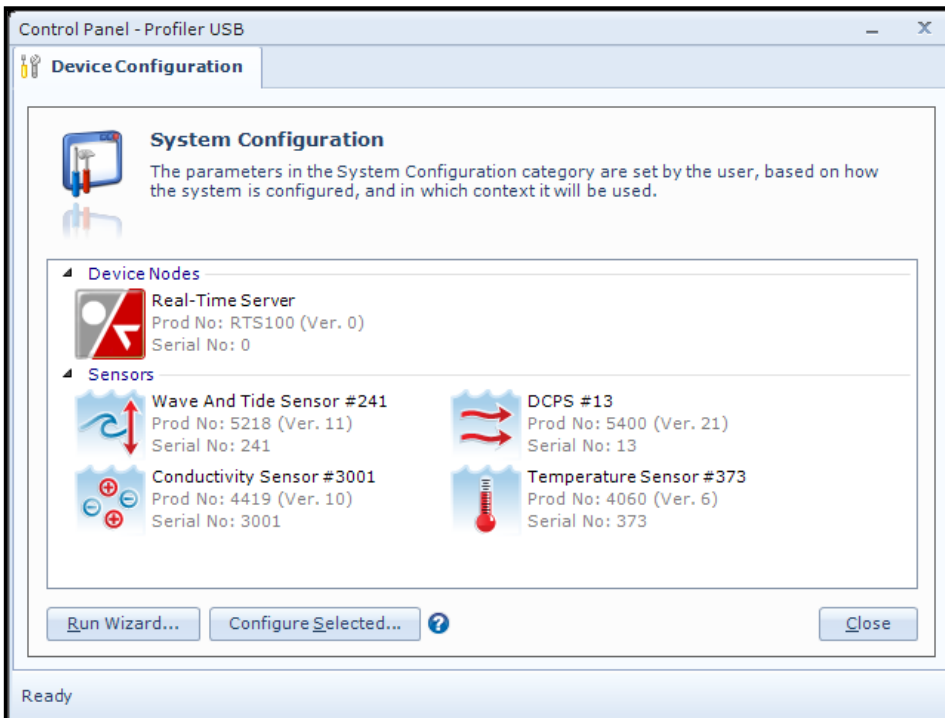

Select **System Configuration** under **Device Configuration** (refer **Figure 3-9**). The different sensors connected to the same Datalogger will show up as selectable items, Refer **Figure 3-25**.

Double-click on the DCPS to start configure

Figure 3-25: System configuration

System Configuration

DCPS #43
Doppler Current Profiler Sensor (5400, Version 47)
Serial No: 43

Orientation

Property	Value
<input checked="" type="radio"/> Enable Tilt Compensation	<input checked="" type="checkbox"/>
<input checked="" type="radio"/> Enable Fixed Heading	<input type="checkbox"/>
<input type="radio"/> Fixed Heading (Deg.M)	0
<input checked="" type="radio"/> Enable Upside Down	<input type="checkbox"/>

Wave Measurement

Property	Value
<input checked="" type="radio"/> Enable Wave Measurement	<input type="checkbox"/>
<input type="radio"/> Wave Integration Time	30 min
<input type="radio"/> Wave Sampling Frequency	2 Hz
<input checked="" type="radio"/> Significant Wave Height Unit	Metric [m]

Current Profile Measurement

Property	Value
<input checked="" type="radio"/> Bandwidth	Narrowband
<input checked="" type="radio"/> Enable Ambiguity Lock	<input type="checkbox"/>
<input checked="" type="radio"/> Ping Number	300
<input checked="" type="radio"/> Enable Burst Mode	<input type="checkbox"/>
<input type="radio"/> Burst Period Placement	End Of Interval

Surface

Property	Value
<input checked="" type="radio"/> Enable Surface Cell	<input type="checkbox"/>
<input type="radio"/> Surface Cell Size	1.0m

Column 1

Property	Value
<input checked="" type="radio"/> C1 Enable Surface Reference	<input checked="" type="checkbox"/>
<input checked="" type="radio"/> C1 Cell Size	2.0m
<input checked="" type="radio"/> C1 Distance First Cell Center	3.0m
<input checked="" type="radio"/> C1 Number Of Cells	20
<input checked="" type="radio"/> C1 Cell Center Spacing	1.0m

Column 2

Property	Value
<input checked="" type="radio"/> C2 Enable Column	<input type="checkbox"/>
<input type="radio"/> C2 Enable Surface Reference	<input type="checkbox"/>
<input type="radio"/> C2 Cell Size	1.0m
<input type="radio"/> C2 Distance First Cell Center	3.0m
<input type="radio"/> C2 Number Of Cells	50
<input type="radio"/> C2 Cell Center Spacing	0.2m

Column 3

Property	Value
<input checked="" type="radio"/> C3 Enable Column	<input type="checkbox"/>
<input type="radio"/> C3 Enable Surface Reference	<input checked="" type="checkbox"/>
<input type="radio"/> C3 Cell Size	1.0m
<input type="radio"/> C3 Distance First Cell Center	3.0m
<input type="radio"/> C3 Number Of Cells	3
<input type="radio"/> C3 Cell Center Spacing	10.0m

Column 4

Property	Value
<input checked="" type="radio"/> Enable Current From Wave Pings	<input checked="" type="checkbox"/>

System Configuration is separated in 14 groups. The settings in these groups are mainly used to configure the sensor and control the output/ storage of data. Refer chapter 1.7.3 for more information on the properties in **System Configuration**.

If you change mode you might need to go back to the Recorder panel and **Refresh Status** and or **Stop Recorder** before you can continue to configure.

Some of the settings are only available if Acoustic Wave is enabled. The Acoustic wave module is a licensed option. Older units and units without Acoustic wave can also be upgraded, either by user or at the factory

The Mode setting will also influence some of the alternatives in the rest of the session.

For more information on each property see chapter 3.6.1 to 3.6.14.

Figure 3-26: Sensor Configuration part 1

Output/Storage - Wave Parameters	
Property	Value
Wave Mean Direction Output	Off
Wave Mean Period Tm02 Output	Off
Wave Energy Period Tm-10 Output	Off
Energy Spectrum Output	Off
Directional Spectrum Output	Off
Principal Dir Spectrum Output	Off
Orbital Ratio Spectrum Output	Off
Fourier Coeff Spectrum Output	Off
Wave Quality Output	Off
Wave Depth Cell Output	Storage

Output/Storage - Profile Parameters	
Property	Value
Select Profile Parameters	User Specified
Enable 4-Beam Auto Replacement	<input type="checkbox"/>

User Specified - Profile Parameters	
Property	Value
NE Speed Output	Off
3-Beam Combination Output	Off
AutoBeam Output	Off
AutoBeam Speed Type	Polar
Vertical Speed Output	Off
Strength Output	Off
Beam Speed Output	Off
Beam Strength Output	Off
Std Dev Speed Output	Off
Std Dev Beam Speed Output	Off
Cross Difference Output	Off
Correlation Factor Output	Off
Noise Level Output	Off

Output/Storage - Sensor Parameters	
Property	Value
Heading Output	Off
Pitch Roll Output	Off
Abs Tilt Output	Off
Max Tilt Output	Off
Tilt Direction Output	Off
Std Dev Heading Output	Off
Std Dev Tilt Output	Off

Output/Storage - System Parameters	
Property	Value
Charge Voltage Output	Storage
Memory Used Output	Storage
Voltage Output	Storage
Current Output	Storage
Air Detect Output	Storage

Output/Storage - Virtual Sensors	
Property	Value
Speed Of Sound Output	Storage
Depth Output	Storage
Salinity Output	Storage
Density Output	Storage

In the second half of the **System Configuration** menu you will find mainly setting that will control the output

If **User Specified** is selected under **Output/Storage – Profile Parameters>Select Profile Parameters** then the individual selection in the next menu **User Specified – Profile Parameters** will be valid. For all other settings in **Select Profile Parameters** the selections of parameters in **User Specified – Profile Parameters** will be overruled.

NOTE!! **User Specified – Profile Parameters** are only valid when **Select Profile Parameter** is set to **User Specified**,

The selection for each property in these menus will also be dependent on the mode setting

For the DCPS connected to a SeaGuardII or SmartGuard it is possible to select: **Off**, **Storage** or **Output+Storage**.

If set to **Off**, the sensor does not output data. If set to **Storage**, the Datalogger only saves the data to the SD-card (if inserted). If **Output+Storage** is selected, the Datalogger saves the data to the SD-card and includes the data in the real-time output from the Datalogger (if real-time output is enabled).

More details on how to enable real-time data output can be found in the TD 303, manual for SeaGuardII platform, Chapter 6 and TD 293, manual for SmartGuard.

Figure 3-27: Sensor Configuration part 2

3.6.1 Orientation

Orientation	
Property	Value
<input checked="" type="checkbox"/> Enable Tilt Compensation	<input checked="" type="checkbox"/>
<input checked="" type="checkbox"/> Enable Fixed Heading	<input type="checkbox"/>
<input type="radio"/> Fixed Heading (Deg.M)	0
<input checked="" type="checkbox"/> Enable Upside Down	<input type="checkbox"/>

Figure 3-28: Orientation

Enable Tilt Compensation is recommended to set active at all time because then the sensor will automatically compensate for any tilt.

Enable Fixed Heading might be used if there is any magnetic disturbance that might interfere with a compass heading and the instrument has a fix position. Then Fixed Heading (Deg.M) can be used to set the offset between the Sensor North direction and the Magnetic North.

The upside down orientation setting should always be set the same way as the intended use; if the sensor is intended to be deployed upward looking, do not tick the **“Enable Upside Down”**. If the sensor is intended to be deployed downward looking, tick the **“Enable Upside Down”**.

However, the sensor will work even if the orientation setting is defined as the opposite of the used direction; it is able to sense the orientation itself and corrects the calculated current directions, heading etc. accordingly. **NB! The surface cell and surface reference of columns does not work if the sensor is orientated upside down while running (forced to be sensor referenced instead)**. A status flag in the record status output parameter is also set to indicate that the sensor has been used in the opposite direction to the configured direction.

3.6.2 Wave Measurement

Wave Measurement	
Property	Value
<input checked="" type="checkbox"/> Enable Wave Measurement	<input type="checkbox"/>
<input type="radio"/> Wave Integration Time	30 min ▼
<input type="radio"/> Wave Sampling Frequency	2 Hz ▼
<input checked="" type="radio"/> Significant Wave Height Unit	Metric [m] ▼

Figure 3-29: Wave Measurement

This menu is only available if Acoustic wave license is enabled. If not available ask factory for upgrade possibilities.

Enable Wave Measurement must be selected to measure acoustic wave

Wave Integration Time is the integration time used to calculate waves. Number of samples divided by **Wave Sampling Frequency** gives the minimum **Wave Integration Time**.

Wave Sampling Frequency is the ping frequency during wave measurement. Available settings are 2Hz or 4Hz.

Significant Wave Height Unit is the unit used for Significant wave height, Alternative is Metric (m) or Imperial (ft)

3.6.3 Current Profile Measurement

Current Profile Measurement	
Property	Value
<input checked="" type="radio"/> Bandwidth	Narrowband
<input checked="" type="radio"/> Enable Ambiguity Lock	<input type="checkbox"/>
<input checked="" type="radio"/> Ping Number	300
<input checked="" type="radio"/> Enable Burst Mode	<input type="checkbox"/>
<input type="radio"/> Burst Period Placement	End Of Interval

Figure 3-30: Current Profile Measurement

The sensor can select between two **Bandwidths**, either **Narrowband** or **Broadband** to find the Doppler shift (and calculate the current parameters); see the DCPS Primer TD 310 for more details.

The two methods have their own advantages:

- **Broadband** gives a lower single ping standard deviation which requires fewer ping (lower energy usage) to get a good measurement result. The disadvantage in **Broadband** is ambiguity. If the sensor is fixed, for example when deployed in a bottom frame, the ambiguity is not a problem (ambiguity lock disabled). If it is moving and the user knows that the current speeds are always below 1 m/s, enable the ambiguity lock.
- If the sensor is moving (as under a buoy for example) and the current speeds are higher than 1m/s, it is recommended to use **Narrowband**. Though **Narrowband** is more power consuming than **Broadband**, the reached measuring range is slightly longer than in **Broadband** mode.

Enable Ambiguity Lock is only used with **Broadband**. In **Broadband** the output of the correlation process is a phase value. When the Doppler shift is zero then the phase is also zero. When the Doppler shifts increase, so will the phase. A Doppler shift of approximately 1.25 m/s along the beam corresponds to a phase equal to 360 (360 = 0) which is exactly the same as for zero Doppler shift. For this reason the cross correlation process is not able to distinguish a Doppler shift of 1.5 from a Doppler shift of zero. In fact any Doppler shift outside the 1.25m/s range will be wrongly detected to be within the range 0 – 1.25 m/s. This is called ambiguity and could hamper the correct operation of the instrument if not corrected for. If ambiguity lock is enabled the result will stay in the first loop also between 0 and 1.25 m/s so if you know the current will be below 1.25 m/s you can use **Ambiguity Lock** and avoid any error caused by ambiguity,

In case the ambiguity lock is not selected, several stages of ambiguity solving methods are automatically implemented in the DCPS in order to achieve a non-ambiguous solution.

Ping Number is the number of ping transmitted during one recording interval. One ping is a transmitted pulse from all transducers. These four pulses are sent out simultaneously in four directions.

Enable Burst Mode. The sensor can run in burst mode or spread mode. When burst mode is enabled the sensor performs all ping measurements at the beginning or end of the recording interval, dependent on the Burst Period Placement setting. This can be set to either **Start Of Interval** or **End Of Interval**. If it is disabled the ping measurements are evenly spread out during the recording interval. The instrument activates sleep mode between each measurement, which reduces the power consumption. Power consumption in spread and burst mode is about the same. Refer [Figure 3-30](#).

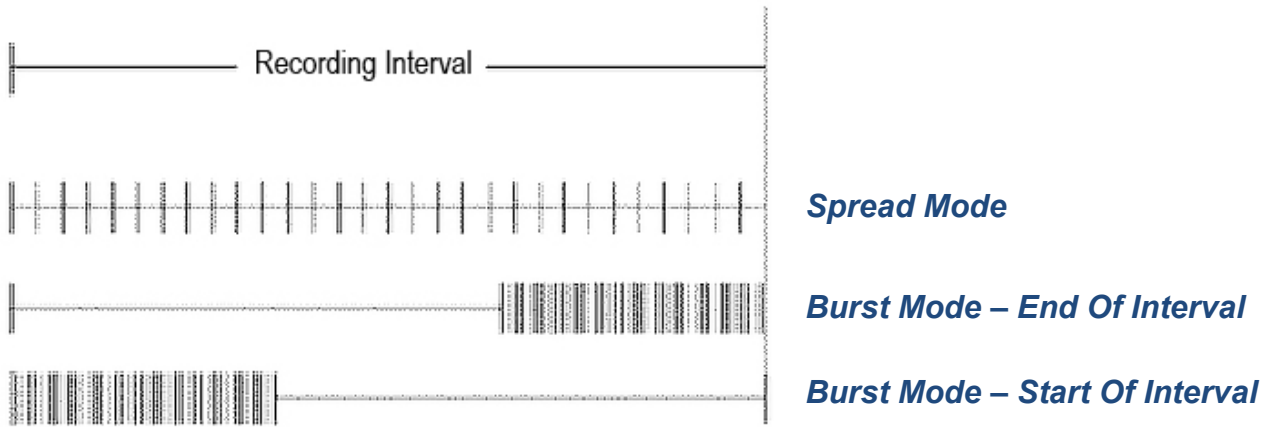

Figure 3-31: Spread mode and burst mode ping distribution during the recording interval

3.6.4 Surface

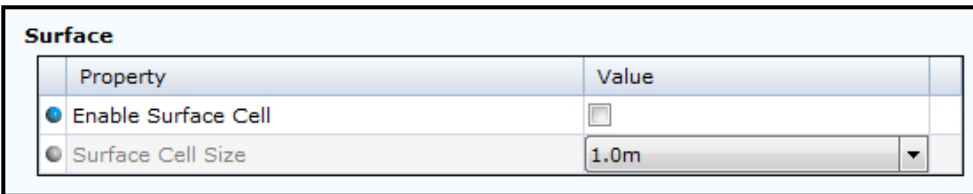

Figure 3-32: Surface

Enable Surface Cell will set a cell in the surface layer. The data is set as not valid if the sensor is placed upside down with the surface cell enabled. **Surface Cell Size** or the measurement “window” is centred on the surface. At the surface, the impedance difference between the water and air creates an almost perfect reflector, and the acoustic signal is reflected by the surface. Regardless of the cell size used to process the surface cell, this cell will be dominated by the infinitesimal thin layer between water and air. Although the surface cell is infinitesimal small, the cell size used to process the data must be sufficiently large to capture the boundary between air/water defining the surface cell.

The surface cell will reflect the speed of the “boundary condition”. Wind will generate capillary waves, and rapidly accelerate the surface boundary. For this reason there will be a strong correlation between wind speed/surface boundary speed and wind direction / surface boundary direction.

NB! Do not use Surface Cell or Surface Reference together with Upside Down enabled, refer chapter 3.6.1.

The surface reference is ignored if the sensor is upside down while it is running (columns forced to be sensor referred).

If instrument is oriented **Upside Down** the surface cell is ignored and the data is set as non-valid.

3.6.5 Column 1

Column 1	
Property	Value
<input checked="" type="checkbox"/> C1 Enable Surface Reference	<input checked="" type="checkbox"/>
<input checked="" type="checkbox"/> C1 Cell Size	2.0m
<input checked="" type="checkbox"/> C1 Distance First Cell Center	3.0m
<input checked="" type="checkbox"/> C1 Number Of Cells	20
<input checked="" type="checkbox"/> C1 Cell Center Spacing	1.0m

Figure 3-33: Column 1

The sensor does not have any depth measurement itself. Be aware that you have to set correct fixed settings under Deployment settings if you want to use the Surface Cell or Surface Reference of columns. It is possible to update these fixed settings while the sensor is running (not possible through Real-Time Collector without stopping and starting the sensor again). NOTE: this functionality is especially interesting when the deployment location shows some sea level variations as the tide. In this case the column will follow the surface variation but this is dependent on the input of pressure value. If you are using a surface referred column with fixed settings, the results will not reflect the water level changes.

In AiCaP mode when connected to a SmartGuard or SeaGuardII, the sensor can receive input from other sensors connected to the same Datalogger. See Chapter 5.4 for more details.

Column 1 is always active (not possible to disable). Column 1 can have up to 75 cells. Column 2 can have up to 50 cells and Column 3 can have up to 25 cells (150 cells all together). Columns 2 and 3 have to be enabled to be used.

C1 Enable Surface Reference: If set the cells will be referenced to the surface. The surface placement is measured by a pressure sensor prior to start of each recording interval. If not enabled the cells will be referenced to the transducers and located at certain distance from the transducer head.

C1 Cell Size: Whether the instrument is configured in broadband or narrowband, the user needs to configure the cell size (from 0.5 to 5m). The cell could be defined as the volume of water in which the instrument is performing the measurement. By defining the cell size, the number of cells, the cell centre spacing and knowing the speed of sound, the instrument determines the time frame when the reflected signal from the corresponding cell will be received.

C1 Distance First Cell Center: available range 1.5 to 70 meter. This will depend on the **C1 Enable Surface Reference** setting. If surface referenced it will be the distance from surface to centre of first cell. The minimum recommended distance will be the illegible zone, area not measured because of disturbance from side lobes, plus half the cell size. As a thumb of rules the illegible zone where signal is disturbed by side lobes is 10% of the deployment depth due to shorter distance to surface for the side lobes pointing upwards compared to the main lobes and the high reflection from the surface layer. The minimum distance to first cell centre should therefore be 10% of deployment depth plus half the cell size. If instrument referenced the minimum distance to first cell should be 1 meter blanking zone for 5400 and 2 meter for 5402 and 5403, plus half the cell size. This blanking zone is due to the fact that the instrument using the same transducers for transmitting the signal as used for receiving. For more information see Chapter 5 of TD 310 DCPS Theoretical Primer.

C1 Number OF Cells: Available from 1 to 75 cells. The instrument can measure multiple cells along the column from instrument to the maximum range given by the scatter condition, or from surface and down to the instrument dependent on the configuration.

C1 Cell Center Spacing is used to either obtain overlap between cells or spacing. If **Cell Center Spacing** is set to smaller than cell size the two following cells will overlap each other. This gives you higher resolution for the post processed data and makes it easier to locate special incidents like thermocline layers etc. If spacing is equal to cell size then two following cells will be adjacent to each other. If spacing is greater than cell size then there will be space between two following cells. This is useful if you want to measure only at certain depths for example 5, 15 and 25 meter from surface. To obtain this then set **Enable Surface Reference** enable, **Cell Size** 2 meter, **Distance First Cell Center** 5 meter, **Number Of Cell** 3 and **Cell Center Spacing** 10 meter.

3.6.6 Column 2

Column 2	
Property	Value
<input checked="" type="radio"/> C2 Enable Column	<input type="checkbox"/>
<input type="radio"/> C2 Enable Surface Reference	<input type="checkbox"/>
<input type="radio"/> C2 Cell Size	1.0m
<input type="radio"/> C2 Distance First Cell Center	3.0m
<input type="radio"/> C2 Number Of Cells	50
<input type="radio"/> C2 Cell Center Spacing	0.2m

Figure 3-34: Column 2

C2 Enable Column: If you want more columns. The columns can be different, mix of both reference and configuration. Typical combination is one column covering the whole water column, one surface referenced with high resolution near surface and one instrument reference near bottom.

C2 Enable Surface Reference: Same as for C1 see chapter 3.6.5

C2 Cell Size: Same as for C1 see chapter 3.6.5

C2 Distance First Cell Center: Same as for C1 see chapter 3.6.5

C2 Number OF Cells: Available from 1 to 50 cells. The instrument can measure multiple cells along the column from instrument to the maximum range given by the scatter condition, or from surface and down to the instrument dependent on the configuration.

C2 Cell Center Spacing: Same as for C1 see chapter 3.6.5

3.6.7 Column 3

Column 3	
Property	Value
<input checked="" type="radio"/> C3 Enable Column	<input type="checkbox"/>
<input type="radio"/> C3 Enable Surface Reference	<input checked="" type="checkbox"/>
<input type="radio"/> C3 Cell Size	1.0m
<input type="radio"/> C3 Distance First Cell Center	3.0m
<input type="radio"/> C3 Number Of Cells	3
<input type="radio"/> C3 Cell Center Spacing	10.0m

Figure 3-35: Column 3

C3 Enable Column: Same as for C2 see chapter 3.6.6

C3 Enable Surface Reference: Same as for C1 see chapter 3.6.5

C3 Cell Size: Same as for C1 see chapter 3.6.5

C3 Distance First Cell Center: Same as for C1 see chapter 3.6.5

C3 Number OF Cells: Available from 1 to 25 cells. The instrument can measure multiple cells along the column from instrument to the maximum range given by the scatter condition, or from surface and down to the instrument dependent on the configuration.

C3 Cell Center Spacing: Same as for C1 see chapter 3.6.5

3.6.8 Column 4

Column 4	
Property	Value
<input checked="" type="radio"/> Enable Current From Wave Pings	<input checked="" type="checkbox"/>

Figure 3-36: Column 4

Enable Current From Wave Pings. A profiler are normally not able to measure Acoustic Wave and Current simultaneously because the sensor using the same transducer for both operations. However with the DCPS you might set the **Enable Current From Wave Ping** which make it possible to use the data from Wave measurement pings to also calculate a reduced column with current. This is presented in **Column 4** when enabled. This column is limited to only measure in 3 different cells and these cells are controlled by the setting under **User Maintenance** and **Wave Measurement**, refer chapter 3.7.5.

3.6.9 Output/Storage Wave Parameters

Output/Storage - Wave Parameters	
Property	Value
Wave Mean Direction Output	Off
Wave Mean Period T_{m02} Output	Off
Wave Energy Period T_{m-10} Output	Off
Energy Spectrum Output	Off
Directional Spectrum Output	Off
Principal Dir Spectrum Output	Off
Orbital Ratio Spectrum Output	Off
Fourier Coeff Spectrum Output	Off
Wave Quality Output	Off
Wave Depth Cell Output	Storage

The Wave output parameters can be controlled by the user. Alternative options for each parameter are Off, Storage or Output+Storage where Off means the parameter is not calculated. Storage means that the parameter is only stored on the SD-card and Output+ Storage means the parameter will be transmitted on the Real-Time output in addition to storage on the SD-card.

Figure 3-37: Output/Storage - Wave Parameters

Significant Wave Height H_{m0} and **Significant Wave Height $H_{1/3}$** is always both output and stored while the other parameters can be selected as desired by the operator, The following parameters are available for selection. See chapter 8.3 for a description of each parameter calculation.

Wave Mean Direction Output

Wave Mean Period T_{m02} Output

Wave Energy Period T_{m-10} Output

Energy Spectrum Output

Directional Spectrum Output

Principal Dir Spectrum Output

Orbital Ratio Spectrum Output

Fourier Coeff Spectrum Output

Wave Depth Cell Output

3.6.10 Output/Storage Profile Parameters

Output/Storage - Profile Parameters	
Property	Value
<input checked="" type="radio"/> Select Profile Parameters	User Specified ▼
<input checked="" type="radio"/> Enable 4-Beam Auto Replacement	<input type="checkbox"/>

Figure 3-38: Output/Storage - Profile Parameters

While configuring the sensor, it is possible to define which parameters should be calculated and sent from the sensor.

Select Profile Parameters gives the user the choice to either select one of the predefined groups of **Profile Parameter** or you might select your own selection in **User Specified – Profile Parameters** refer chapter 3.6.11, by selecting **User Specified**. The sensor always outputs the **Cell State1 and Cell Stat 2, Horizontal Speed** and **Direction** for all the cells (not possible to disable). Available settings for **Select Profile Parameters** are:

- **Simple Output**
- **Basic Output**
- **Basic + Beam Output**
- **Basic + 3-Beam Output**
- **Basic + Beam + 3-Beam Output**
- **Full Output**
- **User Specified**

Refer **Table 3-1** for parameters included in each group.

Refer to **Table 1-5** for definition of the parameters.

NOTE: Enabling more data also means larger data messages and more time to transfer data.

All profile parameters are an average of each ping data from the last measurement interval.

Enable 4-Beam Auto Replacement. If selected all 4-beam parameters will automatically be replaced with the best 3-beam solution if a disturbance is detected in one of the beam.

Table 3-1: Profile Parameter additional parameters for each group

		Simple Output	Basic Output	Basic + Beam Output	Basic + 3-Beam Output	Basic + Beam + 3-Beam Output	Full Output
Profile parameter	Parameter name						
	Cell State 1	X	X	X	X	X	X
	Cell State 2	X	X	X	X	X	X
	Horizontal Speed	X	X	X	X	X	X
	Direction	X	X	X	X	X	X
NE Speed Output	North Speed		X	X	X	X	X
	East Speed		X	X	X	X	X
Vertical Speed Output	Vertical Speed		X	X	X	X	X
Std Dev Speed Output	SP Stdev Horizontal		X	X	X	X	X
Strength Output	Strength		X	X	X	X	X
Cross Difference Output	Cross Difference		X	X	X	X	X
Beam Speed Output	Beam1 Speed			X		X	X
	Beam2 Speed			X		X	X
	Beam3 Speed			X		X	X
	Beam4 Speed			X		X	X
Beam Strength Output	Beam1 Strength			X		X	X
	Beam2 Strength			X		X	X
	Beam3 Strength			X		X	X
	Beam4 Strength			X		X	X
Std Dev Beam Speed Output	Beam1 Stdev			X		X	X
	Beam2 Stdev			X		X	X
	Beam3 Stdev			X		X	X
	Beam4 Stdev			X		X	X
Correlation Factor Output	Beam1 Correlation Factor			X		X	X
	Beam2 Correlation Factor			X		X	X
	Beam3 Correlation Factor			X		X	X
	Beam4 Correlation Factor			X		X	X
3-Beam Combination Output	SP Stdev Beam123				X	X	X
	SP Stdev Beam124				X	X	X
	SP Stdev Beam134				X	X	X
	SP Stdev Beam234				X	X	X
	North Beam123				X	X	X
	North Beam124				X	X	X
	North Beam134				X	X	X
	North Beam234				X	X	X
	East Beam123				X	X	X
	East Beam124				X	X	X
	East Beam134				X	X	X
	East Beam234				X	X	X

Continue..		Simple Output	Basic Output	Basic + Beam Output	Basic + 3-Beam Output	Basic + Beam + 3-Beam Output	Full Output
3-Beam Combination Output (continue)	Vertical Beam123				X	X	X
	Vertical Beam124				X	X	X
	Vertical Beam134				X	X	X
	Vertical Beam234				X	X	X
AutoBeam Output	SP Stdev AutoBeam						X
	Horizontal Speed AutoBeam						X
	Direction AutoBeam						X
	North AutoBeam						X
	East AutoBeam						X
	Vertical AutoBeam						X
	Point Parameters						
Noise Level Output	Noise Peak Level B1						X
	Noise Peak Level B2						X
	Noise Peak Level B3						X
	Noise Peak Level B4						X
	Noise Average Level B1						X
	Noise Average Level B2						X
	Noise Average Level B3						X
	Noise Average Level B4						X

3.6.11 User Specified – Profile Parameters

Property	Value
NE Speed Output	Off
3-Beam Combination Output	Off
AutoBeam Output	Off
AutoBeam Speed Type	Polar
Vertical Speed Output	Off
Strength Output	Off
Beam Speed Output	Off
Beam Strength Output	Off
Std Dev Speed Output	Off
Std Dev Beam Speed Output	Off
Cross Difference Output	Off
Correlation Factor Output	Off
Noise Level Output	Off

User Specified Profile Parameters settings are setting that only are in use if **User Specified** is selected under **Select Profile Parameters**. For all other settings the group content displayed in **Table 3-1** will overrule the selection and all are stored..

In AiCaP mode the alternatives are **Off**, **Storage** or **Output + Storage**

Figure 3-39: User Specified - Profile Parameters

NE Speed Output outputs the calculated values for **North Speed** and **East Speed** where speed in north and east direction gives a positive value and speed in South and West direction gives a negative value.

3-Beam Combination Output outputs the four 3-Beam solutions, Beam 123, Beam 134, Beam 124 and Beam 234 for each of the four parameters, **SP Stdev Beam** (Single Ping Standard Deviation Beam), **North Beam**, **East Beam** and **Vertical Beam**. This information is useful if there is an obstruction in one of the beams but also important as quality control to decide that there is no disturbance in one or more beams.

AutoBeam Output outputs **SP Stdev AutoBeam** (Single Ping Standard Deviation AutoBeam), **Horizontal Speed, Direction, North, East** and **Vertical Speed** which for each parameter is the automatically selected best combination of either one of the 3-beam solutions or the 4-beam solution. If all five solutions are identical or close to identical the sensor will always select the 4-beam solution because this has more pings and therefore better standard deviation.

AutoBeam Speed Type. If **AutoBeam Output** is selected then **AutoBeam Speed Type** will set the output type for these parameters. Alternative type is **Rectangular, Polar** or **Rectangular + Polar**.

Vertical Speed Output outputs the measured **Vertical Speed** based on the four beams. Alternatively 3 beams if **Enable 4-Beam Auto Replacement** is selected

Strength Output outputs an average of signal strength from the four transducers. Alternatively 3 transducers if **Enable 4-Beam Auto Replacement** is selected

Beam Speed Output outputs the individual speed measurements from each of the four beams

Beam Strength Output outputs the individual signal strength from each of the four beams.

Std Dev Speed Output outputs a calculated **SP Stdev Horizontal** (Single Ping Standard Deviation Horizontal Speed) based on measurements from the four beams. Alternatively three beams if **Enable 4-Beam Auto Replacement** is selected.

Std Dev Beam Speed Output outputs individual standard deviation for each beam.

Cross Difference Output outputs the Cross Difference which is the difference in Doppler shift from transducers on the same axis, for each depth the speed in beam 1 - speed beam 3 + speed beam 2 - speed beam 4 should be close to 0.

Correlation Factor Output outputs the correlation factor for each beam. The result should be close to 0.5. Only for use in Broadband mode.

Noise Level Output outputs the **Noise Peak Level** and **Noise Average Level** for each of the four transducers. The noise level is a measurement done before the ping measurement where the sensor is only listening to the signal received by the transducers. **Noise Peak Level** outputs the highest signal level detected and this gives a good indication on nearby noise sources in the water (other current meters, echo sounders etc.)

3.6.12 Output/Storage - Sensor Parameters

Output/Storage - Sensor Parameters	
Property	Value
Heading Output	Off
Pitch Roll Output	Off
Abs Tilt Output	Off
Max Tilt Output	Off
Tilt Direction Output	Off
Std Dev Heading Output	Off
Std Dev Tilt Output	Off

In this section sensor parameters related to the compass/tilt measurement are enabled or disabled.

Alternatively settings are either **Off**, **Storage** or **Output+Storage**

Figure 3-40: Output/Storage - Sensor Parameters

A compass/tilt measurement is taken for each ping measurement (current speed measurement). One ping consists of one ping from each transducer. The given value is an average of all single measurements from the last measurement interval.

The **Heading** is the angle in degrees between transducer 1 and magnetic north. Turning the sensor clockwise gives an increasing angle. When looking at the sensor from the label side, transducer 1 is the transducer back to the left (refer to Chapter 9.1). When looking at the sensor from the label side with the sensor upside down, transducer 1 is the transducer back to the right.

The tilt is converted to rotational angles, **Pitch** and **Roll**. The rotational angles are used internally when calculating correct heading from the 3D magnetic field vector and correct current speed components from the acoustic beam vectors in each cell. The **Pitch** and **Roll** output is an average from all measurements in the last measurement interval.

The **Heading Output** is the average compass reading referenced to north during one measurement interval.

Pitch Roll Outputs individually outputs **Pitch** and **Roll** as an average for one measurement interval.

Abs Tilt Output (Absolute tilt) is the tilt between the horizontal plane and the sensor's plane. When upside down, the Abs tilt is varying around 180 degree. This is different from the Aanderaa RDCP (previous profiler generation). The new profiler is able to sense if it is upside down or not, and the absolute tilt indicates the actual direction of the sensor when it is running.

Max Tilt Output (Maximum tilt) is the maximum tilt in any direction measured by the sensor during one measurement interval.

Tilt Direction Output is the average of all tilt direction measurement during one measurement interval.

Std Dev Heading Output (Standard Deviation Heading Output). The sensor does one heading measurement for each ping. This is the standard deviation of all the heading measurements during a recording interval.

Std Dev Tilt Output (Standard Deviation Tilt Output). The sensor does one tilt measurement for each ping. This is the standard deviation of all the absolute tilt measurements during a recording interval.

3.6.13 Output/Storage System Parameters

Property	Value
Charge Voltage Output	Storage
Memory Used Output	Storage
Voltage Output	Storage
Current Output	Storage
Air Detect Output	Storage

The sensor can also output different system parameters like voltage, current draw while awake, and voltage to the acoustic transmitter circuits etc. that could be necessary during the QA&QC of data.

Figure 3-41: Output/Storage - System Parameters

Charge Voltage Output is the charge voltage to the acoustic Tx circuits. Important information to see if there is something wrong with the charge electronics or the transducers. Used for troubleshooting.

Memory Used Output gives a number for the used heap memory. Used for troubleshooting.

Voltage Output gives the measured input voltage internally in the sensor. This is a way to see if the input supply voltage starts dropping and also used to check power consumption. Value is dependent on type of battery or if external power is used.

Current Output is the measured input current to the sensor. This can indicate if something is wrong in the internal electronics if it suddenly starts to rise

Air Detect Output is the value measured by the air detects circuit. This is a circuit which detects if the sensor is in air or water

3.6.14 Output/Storage Virtual Sensor

Property	Value
Speed Of Sound Output	Off
Depth Output	Off
Salinity Output	Off
Density Output	Off

The sensor can also calculate some virtual parameters. These are more interesting when the sensor is used on a Datalogger where the sensor can receive external sensor input via the Datalogger.

Figure 3-42: Output/Storage - Virtual Sensor

Speed Of Sound Output is the fixed Sound Of Speed setting or calculated from available inputs.

Depth Output is the calculated depth based on fixed settings or calculated from available inputs.

Salinity Output is the calculated salinity based on fixed settings or calculated from available inputs.

Density Output is the calculated density based on fixed settings or calculated from available inputs.

3.7 User Maintenance

User Maintenance

DCPS #43
 Doppler Current Profiler Sensor (5400, Version 47)
 Serial No: 43

Mandatory

Property	Value
<input checked="" type="radio"/> Node Description	DCPS #43

Site Info

Property	Value
<input checked="" type="radio"/> Owner	

Serial Port

Property	Value
<input checked="" type="radio"/> Interface	RS232

Licensed Options

Property	Value
<input type="radio"/> Acoustic Wave Product Number	5759
<input checked="" type="radio"/> Acoustic Wave Option Key	-1666012583;100375973;-242...

Wave Measurement

Property	Value
<input checked="" type="radio"/> Select Active Wave Cell	Cell 1
<input checked="" type="radio"/> Enable Fixed Wave Cell Depth	<input checked="" type="checkbox"/>
<input checked="" type="radio"/> Wave Cell Center Depth	6.0m

Profiler Dependencies

Property	Value
<input checked="" type="radio"/> Enable Max Tilt Ping Discard	<input checked="" type="checkbox"/>
<input checked="" type="radio"/> Max Tilt Limit Ping Discard (Deg)	60.00
<input checked="" type="radio"/> Distance Pressure To Center TRD (m)	0.187

Under **User Maintenance**, you find properties that are password protected and are set / altered by a trained user. It is not recommended to change properties unless instructed. To access these, check the **“Include User Maintenance”** box in the device configuration before clicking on the **“Get Current Configuration...”** button. The password is: **1000**. The user maintenance settings are accessible by clicking the **“Edit...”** button under **User Maintenance** (refer to **Figure 3-7**).

Figure 3-43: User Maintenance

3.7.1 Mandatory

Mandatory	
Property	Value
● Node Description	DCPS #43

Figure 3-44: Mandatory

Node Description. All sensors are given a **Node Description** text like DCPS #xxx (xxx is the serial number of the sensor). The user can modify this node description text if required. Be aware that the node description changes to *Corrupt Configuration if it has lost the configuration in flash. Contact the factory if this happens. The configuration is saved in two sectors in flash memory. A flash sector can be corrupted if the power is lost during the saving of new configuration. The double flash sector saving ensures that it does not lose the configuration. If one of the sectors is corrupted, the other sector is used and also saved to the corrupt sector.

3.7.2 Site Info

Site Info	
Property	Value
● Owner	

Figure 3-45: Site Info

Owner is only used for information and will be a part of the Meta data from the sensor. Not used in any calculations.

3.7.3 Serial Port

Serial Port	
Property	Value
● Interface	RS232

Figure 3-46: Serial Port

Interface is the interface between sensor and PC used for configuration. The AiCaP version 5400, 5402 and 5403 are using RS-232

3.7.4 Licensed Options

Licensed Options	
Property	Value
<input type="radio"/> Acoustic Wave Product Number	5759
<input checked="" type="radio"/> Acoustic Wave Option Key	-1666012583;100375973;-242...

Figure 3-47: Licensed Options

Acoustic Wave Product Number is only for factory use. Default value is The Acoustic Wave product number 5759.

Acoustic Wave Option Key is used to enable the wave software. If Acoustic wave is ordered a license key with 8 unique numbers are delivered. A License key is generated using product number and serial number and cannot be used on other instruments.

3.7.5 Wave Measurement

Wave Measurement	
Property	Value
<input checked="" type="radio"/> Select Active Wave Cell	Cell 1
<input checked="" type="radio"/> Enable Fixed Wave Cell Depth	<input checked="" type="checkbox"/>
<input checked="" type="radio"/> Wave Cell Center Depth	6.0m

Figure 3-48: Wave Measurement

Select Active Wave Cell. Default setting is Cell 1 the one closest to the surface but you can also select Cell 2 or Cell 3. Each cell is 2 meter cell size and no overlap,

Enable Fixed Wave Cell Depth. If enabled the **Wave Cell Center Depth** setting will be used to set the distance from surface to first cell, If not set the distance will be dynamic and based on depth and wave condition

Wave Cell Center Depth is the distance from surface to first cell center in meter.

3.7.6 Profiler Dependencies

Profiler Dependencies	
Property	Value
● Enable Max Tilt Ping Discard	<input checked="" type="checkbox"/>
● Max Tilt Limit Ping Discard (Deg)	60.00
● Distance Pressure To Center TRD (m)	0.187

Figure 3-49: Profiler Dependencies

Enable Max Tilt Ping Discard if this setting is enabled then if tilt exceeds the **Max Tilt Limit Ping Discard (Deg)** value the ping will not be used. This is used to avoid bad data from ping when the sensor is tilting too much.

Max Tilt Limit Ping Discard (Deg) is the value used to discard ping if **Enable Max Tilt Ping Discard** is enabled. Default value is 60 degrees.

Distance Pressure To Center TRD (m) is used to set the distance from pressure sensor inlet port (the reference level for the pressure sensor) to the centre of the DCPS transducers. Default value is 0.187 meter which is the distance when pressure sensor is mounted on the top-end plate underneath the DCPS.

3.8 Sensor software versions for use together with SeaGuardII / SmartGuard

Sensors with software versions lower than 8.2.4 should be upgraded to newer version. Newer software versions with stand-alone capabilities can also be used on sensors which are meant for use on SeaGuardII/ SmartGuard. This means that sensors with software versions from 8.1.25 can be used both on an Aanderaa Datalogger and as a stand-alone sensor.

Newer sensors are delivered with software version which supports both stand-alone (AADI Real-Time protocol and Smart Sensor Terminal protocol) and Datalogger use (AiCaP protocol on SeaGuardII and SmartGuard).

Sensors with software version 20.4.26 or higher has built-in wave functionality

CHAPTER 4 Logging data via AADI Real-Time Collector

4.1 Logging data on PC

The Real-Time Collector can save the incoming data to file, either to a txt-file or to xml-files.

4.1.1 Enabling file output

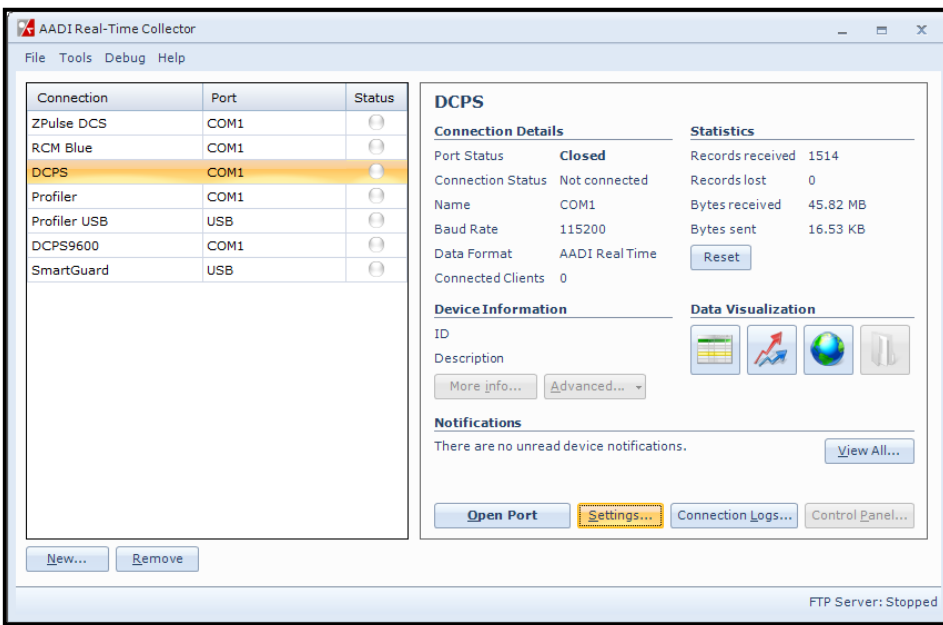

If your connection is open (port open, status green in the AADI Real Time Collector main menu) close the port first to be able to change the file output settings. Click on the connection you are using. Then click on the **“Settings...”** button, as shown in **Figure 4-1**.

Figure 4-1: AADI Real-Time Collector start up menu

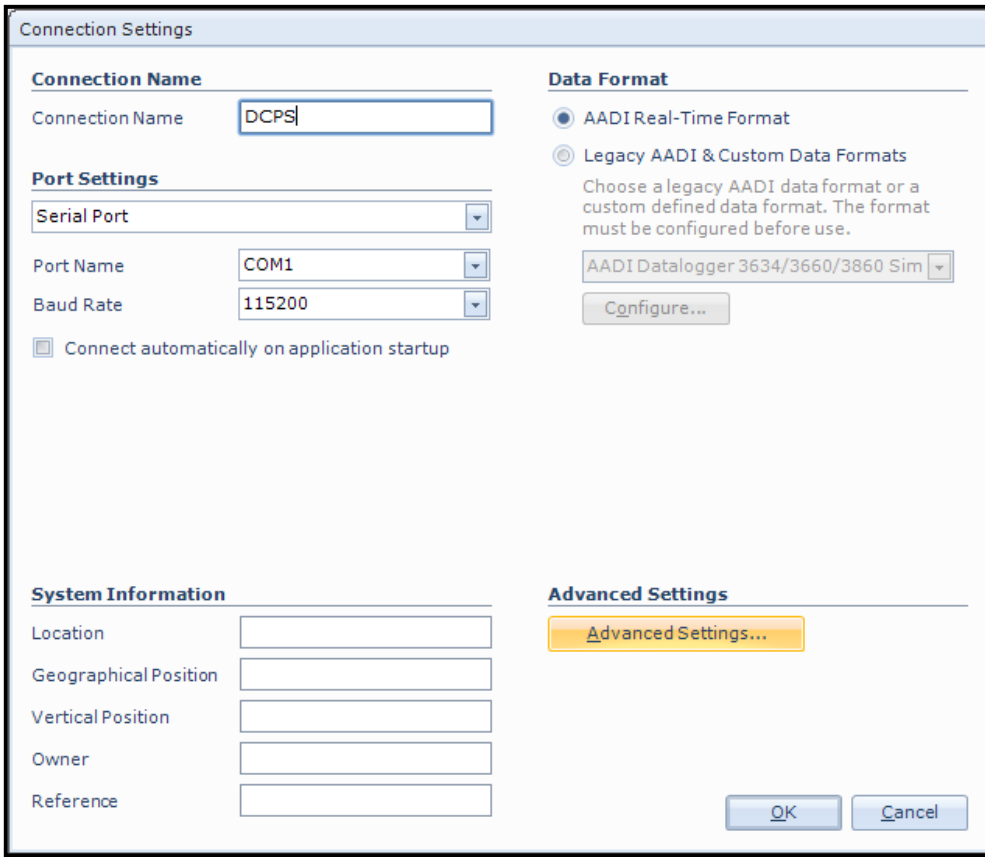

Then click on the “**Advanced Settings...**” button in the Connection Settings window; refer **Figure 4-2**

Figure 4-2: Connection settings menu

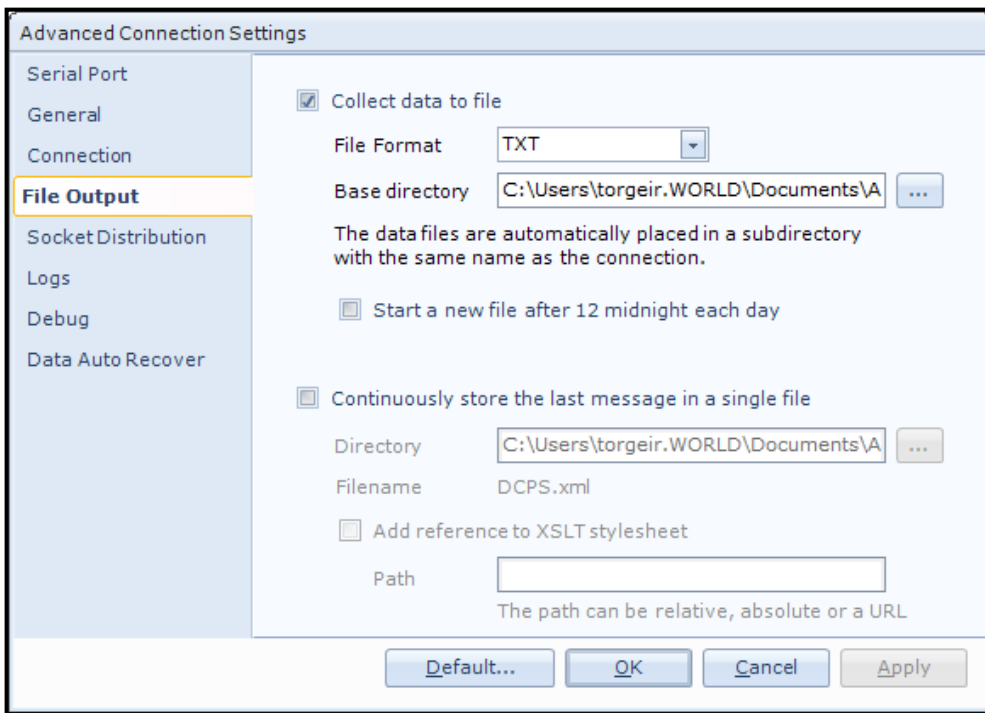

Choose **File Output** from the list on the left side. Check the “**Collect data to file**” box to enable file output. Select a file format either XML or TXT and choose a base directory where you want the file to be saved.

Alternatively you may select “Continuously store the last message in a single file”.

Click “**OK**” in the **Advanced Connection Settings** window, and “**OK**” in the **Connection Settings** window

Figure 4-3: Advanced connection settings / File Output

4.1.2 Starting the sensor and logging to file

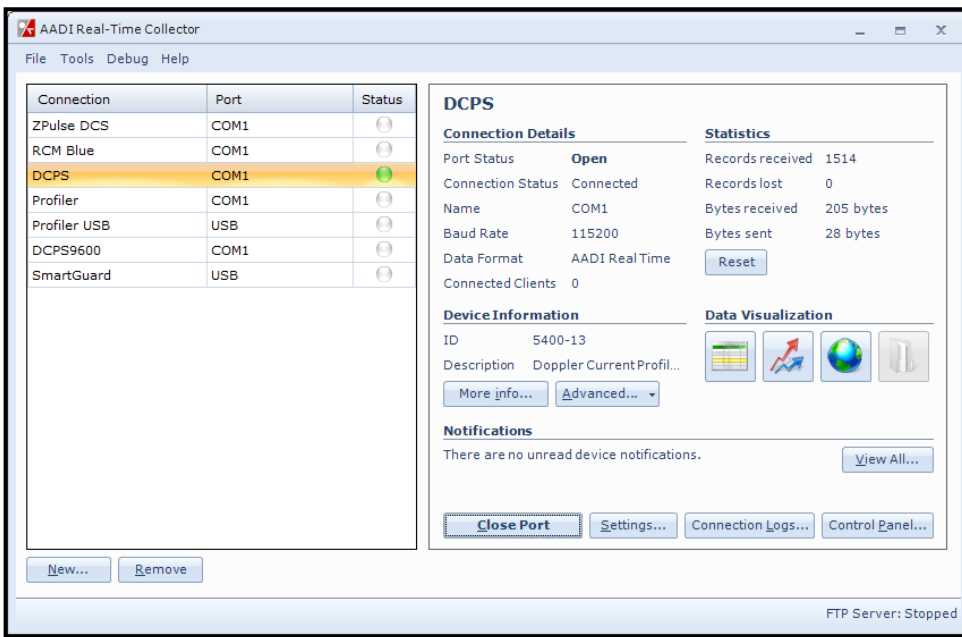

Click on the connection and “**Open Port**”. The Status turns green when the port is opened and connected.

Figure 4-4: AADI Real-Time Collector start up menu

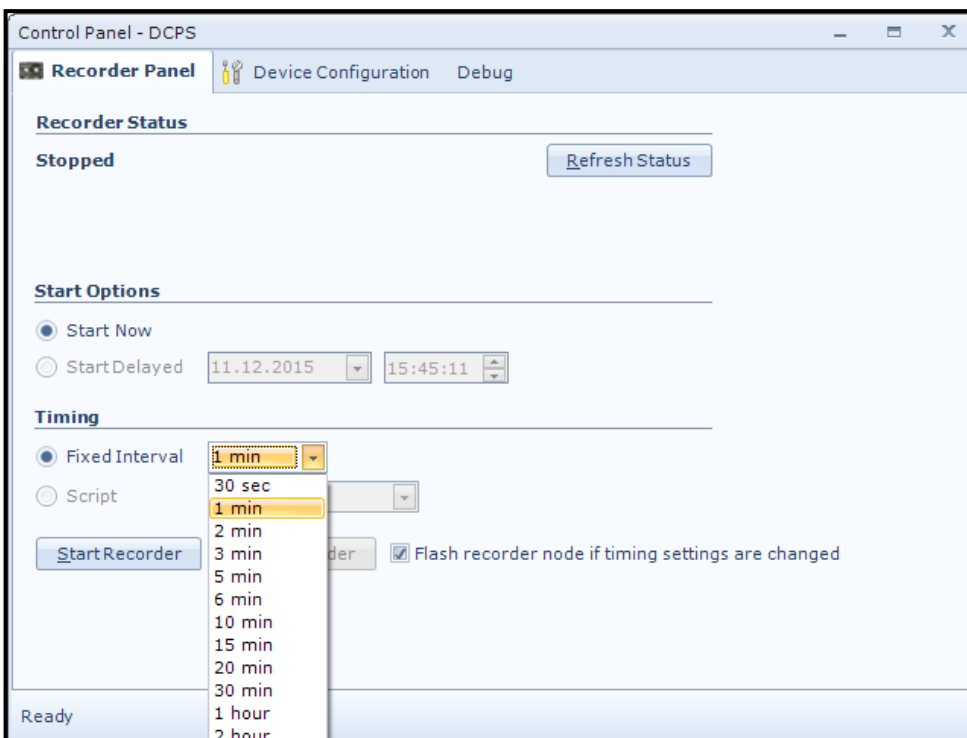

Click on the “**Control Panel...**” button in the lower right corner.

Select the interval duration and click the “**Start Recorder**” button. The shortest interval available depends on the sensor configuration. More cells give longer ping processing time and a higher minimum available recording interval.

Figure 4-5: Recorder panel

Data will start logging in the defined directory. If it is a txt-file, the easiest way to view it is in Excel. [Figure 4-6](#) gives an example of obtained data file. The different parameters are organized in columns.

	A	B	C	D	E	F	G	H	I	J	K
1	Description	Doppler Current Profiler Sensor									
2	Product Name	Doppler Current Profiler Sensor									
3	Product Number	5400									
4	Serial Number	13									
5	Device ID	5400-13									
6	Session ID	5400-13-8.1.38-0-54									
7	Location										
8	Geographic Posit	60.323605,5.37225									
9	Vertical Position										
10	Owner	Aanderaa									
11	Reference										
12											
13											
14		Doppler Current Profiler Sensor									
15											
16											
17											
18	Record Time	Record Number	Sensor Status	Heading [Deg.M]	Status	Std Dev Heading	Status	Pitch [Deg]	Status	Roll [Deg]	Status
19	11.12.2015 15:50	1	(0) OK	2.89E+02		1.08E+00		7.63E-01		8.67E-03	
20	11.12.2015 15:51	2	(0) OK	2.90E+02		8.54E-01		7.45E-01		2.47E-03	
21	11.12.2015 15:51	3	(0) OK	2.90E+02		9.68E-01		7.67E-01		-5.71E-03	
22	11.12.2015 15:52	4	(0) OK	2.89E+02		9.11E-01		7.61E-01		-5.52E-03	
23	11.12.2015 15:52	5	(0) OK	2.89E+02		8.76E-01		7.76E-01		5.02E-03	
24	11.12.2015 15:53	6	(0) OK	2.88E+02		9.46E-01		7.69E-01		5.51E-03	
25	11.12.2015 15:53	7	(0) OK	2.89E+02		9.20E-01		7.84E-01		1.76E-02	

Figure 4-6: Example of a txt-file obtained from the sensor using RT Collector

4.2 Viewing incoming data in real-time

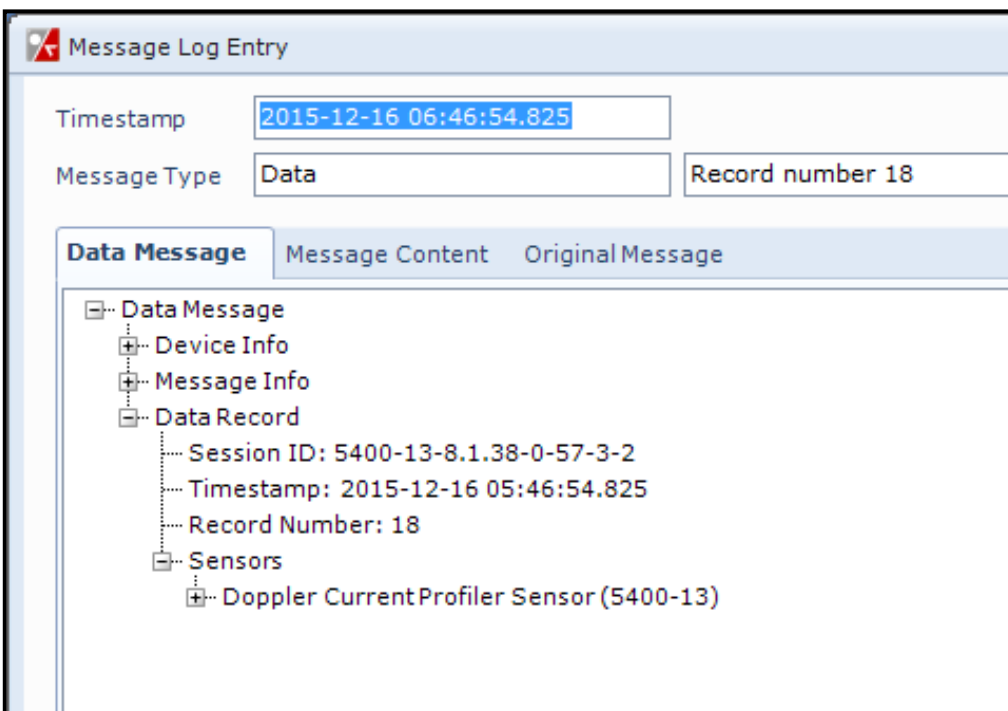

Figure 4-7: Message Log Entry

When the sensor is running, the incoming data can be viewed under “**Connection Logs...**” in the main AADI Real-Time Collector menu (refer to *Figure 4-7* and *Figure 4-8*).

Double-click on one of the Record numbers to look at the data.

Click on the + signs to open up and see all the data in the message.

Message Log Entry

Timestamp: 2015-12-16 06:46:54.825
 Message Type: Data | Record number 18

Data Message | Message Content | Original Message

- Sensors
 - Doppler Current Profiler Sensor (5400-13)
 - Sensor Info
 - Status
 - PointParameters

ID	Description	Value	Range Min	Range Max	Status
2	Heading	291.99 Deg.M	0	360	OK
9	Std Dev Heading	0.94 Deg.M	0	180	OK
3	Pitch	1.33 Deg	-90	90	OK
4	Roll	-0.86 Deg	-180	180	OK
5	Abs Tilt	1.59 Deg	0	180	OK
6	Max Tilt	2.03 Deg	0	180	OK
7	Std Dev Tilt	0.14 Deg	0	90	OK
8	Tilt Direction	296.01 Deg	0	360	OK
76	Speed Of Sound	1500.00 m/s			OK
72	Depth	49.85 m	0	2000	OK
75	Salinity	35.00 PSU			OK
77	Density	1028.07 kg/m^3			OK
135	Charge Voltage Vtx1	5.01 V	0	6	OK
136	Charge Voltage Vtx2	4.97 V	0	6	OK
139	Min Input Voltage	8.78 V	0	30	OK
130	Input Voltage	9.17 V	0	32	OK
131	Input Current	27.35 mA	0	1000	OK
132	Memory Used	117072 Bytes	0	589824	OK
20	Air Detect	375 LSB	0	1023	OK
13	Noise Peak Level B1	-3.09 dB	-80	0	OK
14	Noise Peak Level B2	-1.94 dB	-80	0	OK
15	Noise Peak Level B3	-4.98 dB	-80	0	OK
16	Noise Peak Level B4	-0.79 dB	-80	0	OK
12	Record Status	524798			OK
0	Ping Count	150	0	3600	OK
 - Profiles
 - Profile (200)
 - Columns
 - Column 1
 - Column Info
 - Cells

Index	Cell Status ()	Horizontal Speed (cm/s)	Direction (Deg.M)	North Speed (cm/s)	East Speed (cm/s)	Vertical Speed (cm/s)	SP Stdev Horizon
0	0	167.33	337.00	154.02	-65.38	4.28	1.19
1	0	167.33	337.00	154.02	-65.38	4.28	1.19
2	0	167.33	337.00	154.02	-65.38	4.28	1.19
3	0	167.33	337.00	154.03	-65.38	4.28	1.19
4	0	167.33	337.00	154.03	-65.38	4.28	1.19
5	0	167.33	337.00	154.03	-65.38	4.28	1.19
6	0	167.33	337.00	154.03	-65.38	4.28	1.19
7	0	167.33	337.00	154.03	-65.38	4.28	1.19
8	0	167.33	337.00	154.03	-65.38	4.29	1.19
9	0	167.34	337.00	154.03	-65.38	4.29	1.18

Previous Entry | Next Entry | Always show last entry

Figure 4-8: Visualization of incoming data from the sensor in real time

Previous records or newer records can be viewed by clicking on **Previous Entry** button or **Next Entry** button. An automatic update to the last data message can be enabled by checking the Always show last entry check box.

The original message content can be seen if clicking on the Original Message tab.

CHAPTER 5 Stand-alone Sensor configuration using Smart Sensor Terminal

This chapter describes how to communicate with the Doppler Current Profiler sensor using the RS-232/RS-422 Smart Sensor Terminal protocol.

5.1 Sensor versions and interface

The 5400/5402/5403 sensors can be used on a SeaGuardII and SmartGuard (AiCaP) Dataloggers or connected to a RS-232 com-port (PC or other devices with RS232 com-port).

The R-version sensor (5400R/5402R/5403R) supports only RS-422. The R-version cannot be used on SeaGuardII or SmartGuard Dataloggers.

Sensors with RS-422 output must use a cable designed for RS-422 communication when connected to the PC. If your PC does not support RS-422, you can purchase an expansion card or you can use an RS-232 port using a RS-232/RS-422 converter.

5.2 RS-422 transmission line explained

RS-422 has differential transmission lines with twisted pairs. The sensor signals are less influenced by external noise than with RS-232 serial communication, which makes it possible to use longer cables.

RS-422 has one balanced signal pair for the transmitted signal, TXD (also called TXD+ and TXD-) and one balanced signal pair for the received signal, RXD (also called RXD+ and RXD-).

RxD+ and TxD+ are often named B and called non-inverting input and output, respectively.

RxD- and TxD- are often named A and called inverting input and output, respectively.

The EIA standard uses the notation A and B as described above; many manufacturers of signal converters uses the opposite naming (A for non-inverting input/output, and B on inverting input/output) which is not correct.

Note! Always ensure which signal is non-inverting and which is inverting.

Figure 5-1 illustrates the balanced signals of a RS-422 line during transmission of a byte. The non-inverting signal is called TXD+ while the inverting signal is called TXD-.

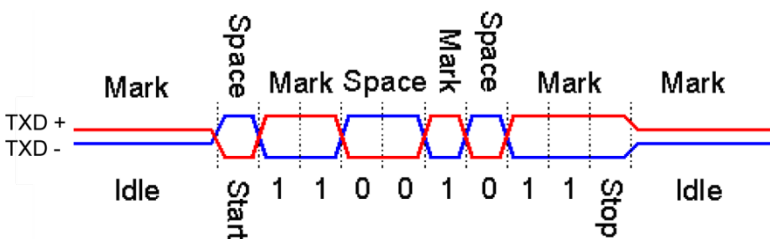

Figure 5-1: RS-422 transmission of a byte

5.3 Communication setup

Most terminal programs can be used for **Smart Sensor Terminal** communication with the sensor when connected to a PC, e.g. Teraterm.

The following Smart Sensor Terminal setup should be used:

- 115200 Baud
- 8 Data bits
- 1 Stop bit
- No Parity
- Xon/Xoff Flow Control

IMPORTANT! The terminal program must send a Line Feed after each Carriage Return.

5.4 Sensor startup

When property **Enable Text** is set to **Yes**, **StartupInfo** is displayed at sensor power up or after **Reset**. **StartupInfo** contains information about **Product Number**, **Serial Number**, **Mode**, **Protocol Version** and **Config Version** (Refer to **Figure 5-2**).

After the first line it also outputs **Initializing...** to indicate that it is busy. When it is ready and has started it outputs

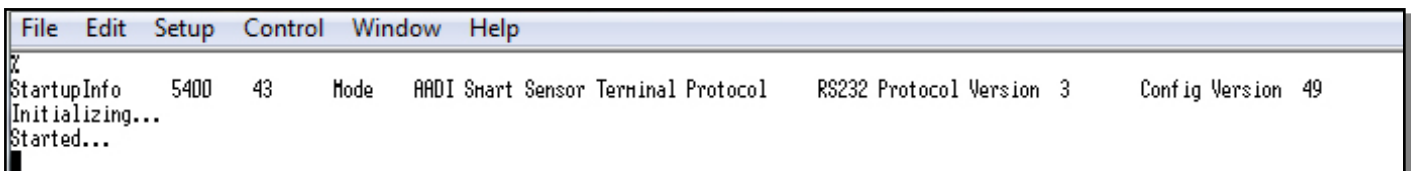

```

File Edit Setup Control Window Help
%
StartupInfo 5400 43 Mode AADI Smart Sensor Terminal Protocol RS232 Protocol Version 3 Config Version 49
Initializing...
Started...

```

Started... The initializing phase can take up to approx. 30s dependent on the configuration of the sensor.

Figure 5-2: Start up info: communication using Tera Term

In order to minimize the current drain the sensor normally enters a power down mode after each sampling; the sensor can be awake by any characters on the Smart Sensor Terminal input, and will stay awake for a time set by the **Comm TimeOut** property after receiving the last character.

If the property **Comm TimeOut** is set to other than **'Always On'** the serial interface will not be activated after power-up (or the **Reset** command). Any character will activate the serial interface, but a Carriage Return (CR or CR+LF), **'/'** or **','** are often preferred since these characters do not interfere with the command syntax. The serial interface will then be active until a period of input inactivity specified by the **Comm TimeOut** value (10 s, 20 s, 30 s, 1 min, 2 min, 5 min, 10 min). The **Communication Sleep Indicator**, **'%'**, will be transmitted when the serial communication is deactivated, and the **Communication Ready Indicator**, **'!'** is outputted subsequent to activation (electronics require up to 500ms start up time). When **Comm TimeOut** is set to **'Always On'** the communication (and microprocessor) will be kept active all time.

The **Communication Sleep Indicator** **'%'** and the **Communication Ready Indicator** **'!'** are not followed by Carriage Return and Line Feed.

Any character will cause the electronics to return to normal operation; when the sensor has responded with the character **‘!’**, new commands may be entered.

When communicating with the sensor, you must start by pressing *Enter*. The sensor will respond in two ways (**Comm TimeOut** is 1 minute by default in the following description):

- If the sensor is ready for communication, it will not send any response indicator. The sensor will stay awake and ready to receive commands for 1 minute (controlled by the **Comm TimeOut**) since the last command.
- If the sensor is in sleep mode and not ready for communication, the sensor will send a ‘communication ready’ indicator (**!**) when awakened (within 500ms). The sensor will then be ready for communication.

The **‘Communication Sleep Indicator ‘%’** and the **‘Communication Ready’ Indicator ‘!’** are not followed by Carriage Return and Line Feed.

5.5 Description of protocol

All inputs to the sensor are given as commands with the following format:

- **MainCmd SubCmd** or **MainCmd Property(Value, ..., Value)**

Description of ASCII coded communication rules:

- The main command, **MainCmd**, is followed by an optional subcommand (**SubCmd**) or sensor property (**Property**).
- The **MainCmd** and the **SubCmd/Property** must be separated with the space ‘ ’ character.
- When entering new settings the **Property** is followed by a parenthesis containing comma-separated values.
- The command string must be terminated by Carriage Return and Line Feed (ASCII code 13 & 10).
- The command string is not case sensitive (UPPER/lower-case).
- The ENUM property settings are case sensitive. E.g. **“Set Mode(AiCaP)”** Here AICAP will result in argument error.
- A valid command string is acknowledged with the character **#** while character ***** indicates an error. Both are followed by Carriage Return/ Line Feed (CRLF).
- For most errors a short error message is also given subsequent to the error indicator.
- There are also special commands with short names and dedicated tasks, as **save**, **reset**, and **help**.
- All names and numbers are separated by tabulator spacing (ASCII code 9).
- The string is terminated by Carriage Return and Line Feed (ASCII code 13 & 10).

Note! Losing power during the flashing process can cause corruption of vital settings, such as coefficients, serial number, model number etc. If losing settings, contact AADI Service department for new setting file for the specific sensor with further instructions.

5.5.1 Save and Reset

When the required properties are set, you should send a **Save** command to make sure that the new configuration is saved internally in the flash memory. The sensor always reads the configuration from the internal flash memory after reset and power up. The **Save** command takes about 20 seconds to complete (indicated with the character '#').

Always send a **Reset** command when a new configuration has been saved (or switch the power OFF and then back ON), or else calculated parameters may be corrupted. This forces the sensor to start up with the new configuration input. If the **Enable Sleep** property is set to **Yes** and the **Comm TimeOut** property is not set to **Always On** the sensor enters sleep mode after reset.

At startup/reset the sensor performs measurements according to the interval setting if the mode is **Smart Sensor Terminal**. If **Enable Text** is set to **Yes**, the **Startup Info** is presented.

If the **Save** command is executed the new setting will be stored in the internal Flash memory.

Property changes will be lost when the sensor is reset or loses power unless you type the **Save** command.

Refer to **Figure 5-3**

```

File Edit Setup Control Window Help
X
StartupInfo 5400 43 Mode AADI Smart Sensor Terminal Protocol RS232 Protocol Version 3 Config Version 49
Initializing...
Started...
MEASUREMENT 5400 43 Heading[Deg.M] 3.344903E+00 Pitch[Deg] 2.235992E+00 Roll[Deg] 1.788083E+02 Record State
524289 Ping Count 10 Cell Index 1000 Cell State1 4080 Cell State2 -256 Horizontal Speed[cm/s] 8.271127E+01
Direction[Deg.M] 5.765503E+01
s!stop
#
set passkey(1)
#
set enable text(no)
#
save
#
reset
#
?5400 43 3.648101E+00 2.195747E+00 1.788307E+02 524289 10 1000 4080 -256 4.121888E+01 1.936370E+02

```

Figure 5-3: Save and reset in Tera Term

5.5.2 Available commands

Available commands and properties for the sensors are given in [Table 5-1](#) and [Table 1-5](#) to [Table 1-8](#) respectively.

Table 5-1: Available RS-232/RS-422 commands

Command	Description
Start	Start a measurement sequence according to current configuration
Stop	Stop a measurement sequence
Do Sample	Calculates and presents a new single set of measurement data. (used in polled mode).
Do Output	Presents the last set of calculated measurement data (normally only used in polled mode).
Do Refresh	Necessary when the sensor is used in Smart Sensor Terminal mode. If the number of ping or one of the column settings is changed, a Do Refresh is necessary to recalculate the Interval and Polled Pingrate limits.
Do Calc Mintime	The sensor calculates the total time it needs for execution of the number of selected pings with the current configuration (number of columns, number of cells etc.) The communication time is also included, i.e. this time is dependent on the number of enabled output parameters and baud rate.
Get <i>ConfigXML</i>	Outputs information about the configuration properties in XML format
Get <i>DataXML</i>	Outputs information about available(enabled) parameters in XML format
Get <i>Property</i>	Output Property value
Get All	Output information about the configuration properties (same as shown on Get <i>ConfigXML</i> but without all the metadata)
Set <i>Property(Value, ..., Value)</i>	Set Property to Value, ..., Value
Set <i>Passkey(Value)</i>	Set passkey to change access level
Save	Store current settings
Load	Reloads previous stored settings
Reset	Resets the sensor with last saved new configuration
Help	Print help information
;	Comment string, following characters are ignored
//	Comment string, following characters are ignored

5.5.3 The Get command

The **Get** command is used to read the value/values of a property and to read the latest value of a parameter.

The command name **Get** followed by a **Property** returns a string in the following format:

Property ProductNo SerialNo Value, ..., Value

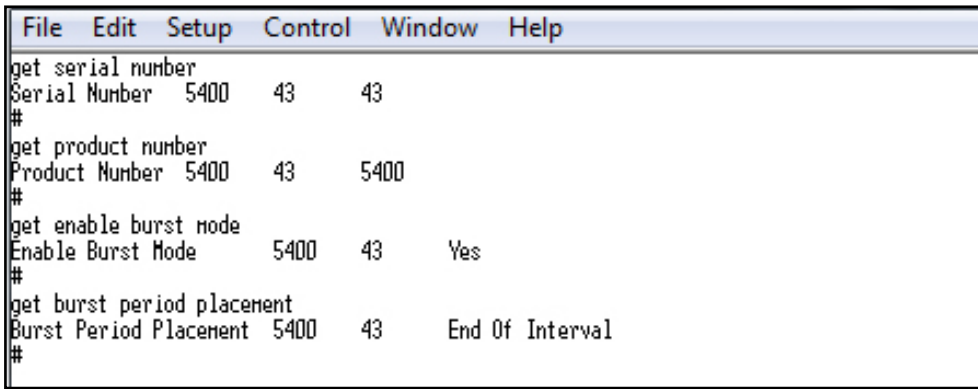

```

File Edit Setup Control Window Help
get serial number
Serial Number 5400 43 43
#
get product number
Product Number 5400 43 5400
#
get enable burst mode
Enable Burst Mode 5400 43 Yes
#
get burst period placement
Burst Period Placement 5400 43 End Of Interval
#

```

The string starts with the name of the property, the product number and serial number of the sensor, and finally the value of the property.

Figure 5-4: The Get Command

The command name **Get** followed by a parameter returns the name and unit of the parameter, the product and serial number of the sensor, and finally the latest parameter reading.

A special version, **Get All**, reads out all available properties in the sensor. Some properties are passkey protected and will not be shown without first writing the passkey. To see all user accessible properties, use passkey **1000**.

5.5.4 The Set command

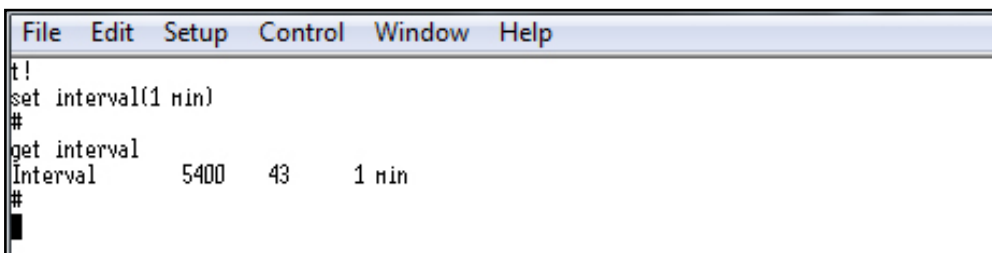

```

File Edit Setup Control Window Help
t!
set interval(1 min)
#
get interval
Interval 5400 43 1 min
#

```

The **Set** command is used for changing a property. The corresponding **Get** command can be used to verify the new setting, as shown in **Figure 5-5**.

Figure 5-5: The Set Command

Use the **Save** commands to permanently store the new property value. Remember to always wait for the acknowledge character **#** after a save before switching off power to the sensor. If the power is lost while saving, the previous configuration saved to flash is used by the sensor.

The **Mode** and **Baudrate** property will require a **Reset** before the change is executed. All other property changes will be executed immediately.

Some properties are passkey protected and will not be accessible without first writing the passkey. If the passkey is needed you get the error message: **“ERROR PROTECTED PROPERTY”**. Using passkey **1000** opens up all user accessible property settings.

5.5.5 XML commands

The **Get ConfigXML** command outputs all available sensor properties in XML-format.

The **Get DataXML** command outputs all available sensor parameters in XML-format.

The **XML-output** is a general format shared by all Aanderaa smart sensors; the output from different types of smart sensors can be read and presented as e.g. in a general smart sensor setup program.

5.5.6 Examples – How to configure sensor in Smart Sensor Terminal mode

Use a terminal program e.g. Tera Term or Hyperterminal, refer chapter 3.3 for communication setup.

In the following examples several configuration changes are shown. The command **Stop** is recommended to avoid output strings while configuring the sensor. If the sensor has started to transmit data when the user tries to communicate, it may take a while before the command response is sent from the sensor. This depends on the number of enabled cells and output parameters etc.

Example 1: Configure 1 column, the other columns disabled

```
//Press Enter to start communicating with the sensor, refer chapter 5.4
↵ //press Enter
Stop ↵ //Wait for ack #. Repeat if necessary
Set Passkey(1) ↵
Set C1 Enable Surface Reference(No) ↵ //wait for ack #
Set C1 Distance First Cell Center(6.0m) ↵ //wait for ack #
Set C1 Cell Size(2.0m) ) ↵ //wait for ack #
Set C1 Number Of Cells(25) ↵ //wait for ack #
Set C1 Cell Center Spacing(2.0m) ) ↵ //wait for ack #
Set C2 Enable Column(No) ↵ //wait for ack #
Set C3 Enable Column(No) ↵ //wait for ack #
Set Enable Surface Cell(No) ↵ //wait for ack #
Do Refresh ↵ //necessary if column settings or ping number is changed before the interval
Set Interval(1 min) //an error message is sent from the sensor if the interval is too short
Save ↵ // wait for ack #
Reset ↵ // the sensor will restart with new settings
```

Comments to example 1:

It is possible to enable the **Surface Cell** and also the **Surface Reference** for the column, but this requires that the sensor knows the correct pressure. The automatic surface referencing was made for the SeaGuardII and SmartGuard where the DCPS can receive the pressure measured directly from the Datalogger via AiCaP(as parameter input from a pressure sensor connected to the same SeaGuardII/SmartGuard).

To use **Surface Reference** on a sensor without a SeaGuardII /SmartGuard with a pressure sensor connected, the user has to set the correct **Fixed Installation Pressure** setting (can be changed while sensor is running).

Column 1 is set up to 25 cells with 2m cell size. Since the Cell Center Spacing is 2m and equal to the Cell Size there will be no overlap and this gives a column which is 2m * 25 = 50m long. Since the Distance First Cell Center is 2m, the column covers from 1m to 51m range from the sensor head. The first cell starts 1 meter away from the head because the distance to first cell center is 2 meter and since the first cell is 2 meter this cell will stretch from 1 meter to 3 meter away from the head

The available/selectable values for Cell Size, Distance to First Cell, Number of Cells and Cell Spacing can be found by sending the command **Help**. This gives a printout from the sensor showing a short help text from the sensor, refer **Figure 5-6**. Setting a value which is not shown here for enumerated properties gives an error message (*ERROR ARGUMENT ERROR).

A **Do Refresh** command should always be sent after a reconfiguration of the column settings, bandwidth or the ping number. This has to be done to be able to show the user an error message if the time settings are out of range (interval or polled ping rate). The shortest interval or highest polled ping rate possible depends on the number of cells, bandwidth (narrowband/broadband), number of pings (non-polled mode) and number of enabled output parameters.

```

File Edit Setup Control Window Help
help
#
Commands: Do_SUBCMD<CRLF>      = Execute SUBCMD
          Get_PROPERTY<CRLF>    = Output PROPERTY value.
          Get_ALL<CRLF>         = Output all property values.
          Get_ALL_Parameters<CRLF> = Output all parameter values.
          Set_PROPERTY(V,...)<CRLF> = Set PROPERTY to V,...V.
          Set_Passkey(W)<CRLF>   = Set Passkey.
          Save<CRLF>            = Store current settings.
          Load<CRLF>            = Load stored settings.
          Reset<CRLF>           = Reset mode.
          Stop<CRLF>            = Stop measurement
          Start<CRLF>           = Start measurement
          Help<CRLF>            = Print help information.

Sub commands: Sample
              Output
              Refresh
              Calc_MinTime
              Set_Clock
              Get_Clock

Argument list for enumerated properties:
Interface: RS232
Baudrate: 4800,9600,57600,115200
Flow Control: None,Xon/Xoff
Conn Timeout: Always 0m,10 s,20 s,1 min,2 min,5 min,10 min
Mode: HiCap,Smart Sensor Terminal,HH01 Real-Time
Polled Pingrate: 0.1 Hz,0.5 Hz,1 Hz,2 Hz
Bandwidth: Narrowband,Broadband
Ping Number: 10,20,30,40,50,60,70,80,90,100,150,200,250,300,400,500,600,800,1200,2400,3600,7200
Burst Period Placement: Start Of Interval,End Of Interval
Surface Cell Size: 0.5m,1.0m,1.5m,2.0m,2.5m,3.0m,3.5m,4.0m,4.5m,5.0m
C1 Cell Size: 0.5m,1.0m,1.5m,2.0m,2.5m,3.0m,3.5m,4.0m,4.5m,5.0m
C1 Distance First Cell Center: 1.5m,1.0m,1.7m,1.8m,1.9m,2.0m,2.1m,2.2m,2.3m,2.4m,2.5m,2.6m,2.7m,2.8m,2.9m,3.0m,3.5m,4.0m,4.5m,5.0m,5.5m,6.0m,6.5m,7.0m,7.5m,8.0m,8.5m,9.0m,9.5m,10.0m,11.0m,12.0m,13.0m,14.0m,15.0m,16.0m,17.0m,18.0m,19.0m,20.0m,22.0m,24.0m,26.0m,28.0m,30.0m,32.0m,34.0m,36.0m,38.0m,40.0m,42.0m,44.0m,46.0m,48.0m,50.0m,55.0m,60.0m,65.0m,70.0m
C1 Number Of Cells: 1,2,3,4,5,6,7,8,9,10,12,14,16,18,20,25,30,35,40,45,50,55,60,65,70,75
C1 Cell Center Spacing: 0.1m,0.2m,0.3m,0.4m,0.5m,0.6m,0.7m,0.8m,0.9m,1.0m,1.1m,1.2m,1.3m,1.4m,1.5m,1.6m,1.7m,1.8m,1.9m,2.0m,2.1m,2.2m,2.3m,2.4m,2.5m,2.6m,2.7m,2.8m,2.9m,3.0m,3.2m,3.6m,4.0m,5.0m,6.0m,7.0m,8.0m,9.0m,10.0m,11.0m,12.0m,13.0m,14.0m,15.0m,17.0m,18.0m,19.0m,20.0m,22.0m,24.0m,26.0m,28.0m,30.0m,32.0m,34.0m,36.0m,38.0m,40.0m,42.0m,44.0m,46.0m,48.0m,50.0m,55.0m,60.0m,65.0m,70.0m
C2 Cell Size: 0.5m,1.0m,1.5m,2.0m,2.5m,3.0m,3.5m,4.0m,4.5m,5.0m
C2 Distance First Cell Center: 1.5m,1.0m,1.7m,1.8m,1.9m,2.0m,2.1m,2.2m,2.3m,2.4m,2.5m,2.6m,2.7m,2.8m,2.9m,3.0m,3.5m,4.0m,4.5m,5.0m,5.5m,6.0m,6.5m,7.0m,7.5m,8.0m,8.5m,9.0m,9.5m,10.0m,11.0m,12.0m,13.0m,14.0m,15.0m,16.0m,17.0m,18.0m,19.0m,20.0m,22.0m,24.0m,26.0m,28.0m,30.0m,32.0m,34.0m,36.0m,38.0m,40.0m,42.0m,44.0m,46.0m,48.0m,50.0m,55.0m,60.0m,65.0m,70.0m
C2 Number Of Cells: 1,2,3,4,5,6,7,8,9,10,12,14,16,18,20,25,30,35,40,45,50
C2 Cell Center Spacing: 0.1m,0.2m,0.3m,0.4m,0.5m,0.6m,0.7m,0.8m,0.9m,1.0m,1.1m,1.2m,1.3m,1.4m,1.5m,1.6m,1.7m,1.8m,1.9m,2.0m,2.1m,2.2m,2.3m,2.4m,2.5m,2.6m,2.7m,2.8m,2.9m,3.0m,3.2m,3.6m,4.0m,5.0m,6.0m,7.0m,8.0m,9.0m,10.0m,11.0m,12.0m,13.0m,14.0m,15.0m,17.0m,18.0m,19.0m,20.0m,22.0m,24.0m,26.0m,28.0m,30.0m,32.0m,34.0m,36.0m,38.0m,40.0m,42.0m,44.0m,46.0m,48.0m,50.0m,55.0m,60.0m,65.0m,70.0m
C3 Cell Size: 0.5m,1.0m,1.5m,2.0m,2.5m,3.0m,3.5m,4.0m,4.5m,5.0m
C3 Distance First Cell Center: 1.5m,1.0m,1.7m,1.8m,1.9m,2.0m,2.1m,2.2m,2.3m,2.4m,2.5m,2.6m,2.7m,2.8m,2.9m,3.0m,3.5m,4.0m,4.5m,5.0m,5.5m,6.0m,6.5m,7.0m,7.5m,8.0m,8.5m,9.0m,9.5m,10.0m,11.0m,12.0m,13.0m,14.0m,15.0m,16.0m,17.0m,18.0m,19.0m,20.0m,22.0m,24.0m,26.0m,28.0m,30.0m,32.0m,34.0m,36.0m,38.0m,40.0m,42.0m,44.0m,46.0m,48.0m,50.0m,55.0m,60.0m,65.0m,70.0m
C3 Number Of Cells: 1,2,3,4,5,6,7,8,9,10,12,14,15,16,17,18,19,20,21,22,23,24,25
C3 Cell Center Spacing: 0.1m,0.2m,0.3m,0.4m,0.5m,0.6m,0.7m,0.8m,0.9m,1.0m,1.1m,1.2m,1.3m,1.4m,1.5m,1.6m,1.7m,1.8m,1.9m,2.0m,2.1m,2.2m,2.3m,2.4m,2.5m,2.6m,2.7m,2.8m,2.9m,3.0m,3.2m,3.6m,4.0m,5.0m,6.0m,7.0m,8.0m,9.0m,10.0m,11.0m,12.0m,13.0m,14.0m,15.0m,17.0m,18.0m,19.0m,20.0m,22.0m,24.0m,26.0m,28.0m,30.0m,32.0m,34.0m,36.0m,38.0m,40.0m,42.0m,44.0m,46.0m,48.0m,50.0m,55.0m,60.0m,65.0m,70.0m
Select Profile Parameters: Simple Output,Basic Output,Basic + Beam Output,Basic + 3-Beam Output,Basic + Beam + 3-Beam Output,Full Output,User Specified
NE Speed Output: Off,Output
3-Beam Combination Output: Off,Output
AutoBeam Output: Off,Output
AutoBeam Speed Type: Polar,Rectangular,Polar+Rectangular
Vertical Speed Output: Off,Output
Strength Output: Off,Output
Beam Speed Output: Off,Output
Beam Strength Output: Off,Output
Std Dev Speed Output: Off,Output
Std Dev Beam Speed Output: Off,Output
Cross Difference Output: Off,Output
Correlation Factor Output: Off,Output
Noise Level Output: Off,Output
Heading Output: Off,Output
Pitch Roll Output: Off,Output
Abs Tilt Output: Off,Output
Max Tilt Output: Off,Output
Tilt Direction Output: Off,Output
Std Dev Heading Output: Off,Output
Std Dev Tilt Output: Off,Output
Change Voltage Output: Off,Output
Memory Used Output: Off,Output
Voltage Output: Off,Output
Current Output: Off,Output
Air Detect Output: Off,Output
Speed Of Sound Output: Off,Output
Depth Output: Off,Output
Salinity Output: Off,Output
Density Output: Off,Output
Interval: 10 sec,20 sec,30 sec,1 min,2 min,3 min,5 min,6 min,10 min,15 min,20 min,30 min,1 hour,2 hour,3 hour
Argument list for properties with default values:
Distance Pressure To Center TRD: 0.187000
Sound Speed: 1473.000000,1500.000000,1525.000000

```

Figure 5-6: Output example from the Help command

See chapter 5.6 for a complete list from the help command including available values for each property.

5.6 Help command output

Commands:

Do_SUBCMD<CRLF>	= Execute SUBCMD
Get_PROPERTY<CRLF>	= Output PROPERTY value.
Get_All<CRLF>	= Output all property values.
Get_All Parameters<CRLF>	= Output all parameter values.
Set_PROPERTY(V,..V)<CRLF>	= Set PROPERTY to V,..V.
Set_Passkey(V)<CRLF>	= Set Passkey.
Save<CRLF>	= Store current settings.
Load<CRLF>	= Load stored settings.
Reset<CRLF>	= Reset node.
Stop<CRLF>	= Stop measurement
Start<CRLF>	= Start measurement
Help<CRLF>	= Print help information.

Sub commands:

Sample

Output
Refresh
Calc MinTime
Set Clock
Get Clock

Argument list for enumerated properties:

Interface:	RS232
Baudrate:	4800,9600,57600,115200
Flow Control:	None,Xon/Xoff
Comm Timeout:	Always On,10 s,20 s,30 s,1 min,2 min,5 min,10 min
Mode:	AiCaP,Smart Sensor Terminal,AADI Real-Time
Polled Pingrate:	0.1 Hz,0.5 Hz,1 Hz,2 Hz
Bandwidth:	Narrowband,Broadband
PingNumber:	10,20,30,40,50,60,70,80,90,100,150,200,250,300,400,500,600,800,1200,2400,3600,7200
Burst Period Placement:	Start Of Interval,End Of Interval
Surface Cell Size:	0.5m,1.0m,1.5m,2.0m,2.5m,3.0m,3.5m,4.0m,4.5m,5.0m
C1 Cell Size:	0.5m,1.0m,1.5m,2.0m,2.5m,3.0m,3.5m,4.0m,4.5m,5.0m
C1 Distance First Cell Center:	1.5m,1.6m,1.7m,1.8m,1.9m,2.0m,2.1m,2.2m,2.3m,2.4m,2.5m,2.6m,2.7m,2.8m,2.9m,3.0m,3.5m,4.0m,4.5m,5.0m,5.5m,6.0m,6.5m,7.0m,7.5m,8.0m,8.5m,9.0m,9.5m,10.0m,11.0m,12.0m,13.0m,14.0m,15.0m,16.0m,17.0m,18.0m,19.0m,20.0m,22.0m,24.0m,26.0m,28.0m,30.0m,32.0m,34.0m,36.0m,38.0m,40.0m,42.0m,44.0m,46.0m,48.0m,50.0m,60.0m,65.0m,70.0m
C1 Number Of Cells:	1,2,3,4,5,6,7,8,9,10,12,15,20,25,30,35,40,45,50,55,60,65,70,75
C1 Cell Center Spacing:	0.1m,0.2m,0.3m,0.4m,0.5m,0.6m,0.7m,0.8m,0.9m,1.0m,1.1m,1.2m,1.3m,1.4m,1.5m,1.6m,1.7m,1.8m,1.9m,2.0m,2.1m,2.2m,2.3m,2.4m,2.5m,2.6m,2.7m,2.8m,2.9m,3.0m,3.2m,3.6m,4.0m,5.0m,6.0m,7.0m,8.0m,9.0m,10.0m,11.0m,12.0m,13.0m,14.0m,15.0m,16.0m,17.0m,18.0m,19.0m,20.0m,25.0m,30.0m
C2 Cell Size:	0.5m,1.0m,1.5m,2.0m,2.5m,3.0m,3.5m,4.0m,4.5m,5.0m
C2 Distance First Cell Center:	1.5m,1.6m,1.7m,1.8m,1.9m,2.0m,2.1m,2.2m,2.3m,2.4m,2.5m,2.6m,2.7m,2.8m,2.9m,3.0m,3.5m,4.0m,4.5m,5.0m,5.5m,6.0m,6.5m,7.0m,7.5m,8.0m,8.5m,9.0m,9.5m,10.0m,11.0m,12.0m,13.0m,14.0m,15.0m,16.0m,17.0m,18.0m,19.0m,20.0m,22.0m,24.0m,26.0m,28.0m,30.0m,32.0m,34.0m,36.0m,38.0m,40.0m,42.0m,44.0m,46.0m,48.0m,50.0m,55.0m,60.0m,65.0m,70.0m
C2 Number Of Cells:	1,2,3,4,5,6,7,8,9,10,12,14,16,18,20,25,30,35,40,45,50
C2 Cell Center Spacing:	0.1m,0.2m,0.3m,0.4m,0.5m,0.6m,0.7m,0.8m,0.9m,1.0m,1.1m,1.2m,1.3m,1.4m,1.5m,1.6m,1.7m,1.8m,1.9m,2.0m,2.1m,2.2m,2.3m,2.4m,2.5m,2.6m,2.7m,2.8m,2.9m,3.0m,3.2m,3.6m

4.0m,5.0m,6.0m,7.0m,8.0m,9.0m,10.0m,11.0m,12.0m,13.0m,14.0m,15.0m,16.0m,17.0m,
 18.0m,19.0m,20.0m,25.0m,30.0m
 C3 Cell Size: 0.5m,1.0m,1.5m,2.0m,2.5m,3.0m,3.5m,4.0m,4.5m,5.0m
 C3 Distance First Cell Center: 1.5m,1.6m,1.7m,1.8m,1.9m,2.0m,2.1m,2.2m,2.3m,2.4m,2.5m,2.6m,2.7m,2.8m,2.9m,
 3.0m,3.5m,4.0m,4.5m,5.0m,5.5m,6.0m,6.5m,7.0m,7.5m,8.0m,8.5m,9.0m,9.5m,10.0m,11.0m,
 12.0m,13.0m,14.0m,15.0m,16.0m,17.0m,18.0m,19.0m,20.0m,22.0m,24.0m,26.0m,28.0m,
 30.0m,32.0m,34.0m,36.0m,38.0m,40.0m,42.0m,44.0m,46.0m,48.0m,50.0m,55.0m,60.0m,
 65.0m,70.0m
 C3 Number Of Cells: 1,2,3,4,5,6,7,8,9,10,11,12,13,14,15,16,17,18,19,20,21,22,23,24,25
 C3 Cell Center Spacing: 0.1m,0.2m,0.3m,0.4m,0.5m,0.6m,0.7m,0.8m,0.9m,1.0m,1.1m,1.2m,1.3m,1.4m,1.5m,1.6m,
 1.7m,1.8m,1.9m,2.0m,2.1m,2.2m,2.3m,2.4m,2.5m,2.6m,2.7m,2.8m,2.9m,3.0m,3.2m,3.6m,
 4.0m,5.0m, 0m,7.0m,8.0m,9.0m,10.0m,11.0m,12.0m,13.0m,14.0m,15.0m,16.0m,17.0m,
 18.0m,19.0m,20.0m,25.0m,30.0m
 Select Profile Parameters: Simple Output,Basic Output,Basic + Beam Output, Basic + 3-Beam Output,
 Basic + Beam + 3-Beam Output,Full Output,User Specified
 NE Speed Output: Off,Output
 3-Beam Combination Output: Off,Output
 AutoBeam Output: Off,Output
 AutoBeam Speed Type: Polar,Rectangular,Polar+Rectangular
 Vertical Speed Output: Off,Output
 Strength Output: Off,Output
 Beam Speed Output: Off,Output
 Beam Strength Output: Off,Output
 Std Dev Speed Output: Off,Output
 Std Dev Beam Speed Output: Off,Output
 Cross Difference Output: Off,Output
 Correlation Factor Output: Off,Output
 Noise Level Output: Off,Output
 Heading Output: Off,Output
 Pitch Roll Output: Off,Output
 Abs Tilt Output: Off,Output
 Max Tilt Output: Off,Output
 Tilt Direction Output: Off,Output
 Std Dev Heading Output: Off,Output
 Std Dev Tilt Output: Off,Output
 Charge Voltage Output: Off,Output
 Memory Used Output: Off,Output
 Voltage Output: Off,Output
 Current Output: Off,Output
 Air Detect Output: Off,Output
 Speed Of Sound Output: Off,Output
 Depth Output: Off,Output
 Salinity Output: Off,Output
 Density Output: Off,Output
 Interval: 10 sec,20 sec,30 sec,1 min,2 min,3 min,5 min,6 min,10 min,15 min,20 min,30 min,1 hour,
 2 hour,3 hour

Argument list for properties with default values:

Distance Pressure To Center TRD: 0.187000
 Sound Speed: 1473.000000,1500.000000,1525.000000

The available sub commands (**Do Sample**, **Do Output**, **Do Refresh** and **Do Calc MinTime**) are listed next. All available values on the enumerated properties are also shown here. Some of the enumerations will change depending on configuration (Polled Pingrate property and Interval property).

The three columns have almost the same available settings. The difference between the three is that column 1 can have up to 75 cells, column 2 up to 50 cells and column 3 up to 25 cells (150 cells totally).

The user is allowed to set up columns which are way too long, the sensor is able to sample approximately 115m, the acoustic range is in most cases much shorter than this (The practical acoustic range varies between 30 and 70m in broadband mode and 35 to 80m in narrowband mode depending on the backscatter conditions). Setting a way too long column does not give an error message. If for example the cell size is 5.0m, number of cells 50 and cell spacing 5m this only gives valid data up to cell 23. The Cell Status parameter on all the rest of the cells will indicate that these are out of range.

Example 2: Setting orientation and measurement properties

```
//Press Enter to start communicating with the sensor, refer chapter 5.4
↵ //press Enter
Stop ↵//Wait for ack #. Repeat if necessary
Set Passkey(1) ↵
Set Enable Upside Down(Yes) ↵//wait for ack #
Set Enable Surface Cell(No) ↵//if it was enabled, has to be disabled with upside down enabled
Set C1 Enable Surface Reference(No) ↵//same as for surface cell
Set C2 Enable Surface Reference(No) ↵//same as for surface cell if column 2 is enabled
Set C3 Enable Surface Reference(No) ↵//same as for surface cell if column 3 is enabled
Set Enable Tilt Compensation(Yes) ↵//wait for ack #
Set Enable Fixed Heading(No) ↵//wait for ack #
Set Bandwidth(Broadband) ↵//wait for ack #
Set Enable Ambiguity Lock(Yes) ↵//wait for ack #
Set Ping Number(20) ↵//wait for ack #
Set Enable Burst Mode(No) ↵//wait for ack #
Set Burst Period Placement(End Of Interval) ↵//wait for ack #
Do Refresh()↵//Bandwidth changed, necessary to do this
Set Interval(2 min) ↵//The present interval can be too short, always wise to try to set again (error if too short)
Save ↵// wait for ack #
Reset ↵// the sensor will restart with new settings
```

Comments to example 2:

When the user wants to use the sensor downwards, the **Upside Down** should be enabled. The sensor is able to sense the orientation itself and it uses the measured orientation when calculating north and east speed components and the correct heading and pitch/roll.

The user is allowed to enable upside down, surface cell and surface reference even if this does not work.

If the sensor is upside down while the surface cell is enabled, the surface cell parameter's status is set to not valid error and the values are zero. If surface referred is enabled, the column is forced to be sensor referred.

If the tilt compensation is disabled, the sensor uses zero tilt for all calculations. The tilt compensation should normally be enabled (default setting from factory). The fixed heading is normally disabled. The fixed heading can be used when the sensor is in a fixed position, for example on a location where the magnetic field is disturbed by something nearby.

Example 3: Output from sensor when all selectable output is off

```
//Press Enter to start communicating with the sensor, refer chapter 5.4
↵ //press Enter
Stop ↵// Stop current measurement. Wait for ack #. Repeat if necessary.
Set Passkey(1) ↵//wait for ack #
Set C1 Number Of Cells(1) ↵//wait for ack #
Set Select Profile Parameters(User Specified) ↵//wait for ack #
Set NE Speed Output(Off) ↵//wait for ack #
Set 3-Beam Combination Output(Off) ↵//wait for ack #
Set AutoBeam Output(Off) ↵//wait for ack #
Set Vertical Speed Output(Off) ↵//wait for ack #
Set Strength Output(Off) ↵//wait for ack #
Set Beam Speed Output(Off) ↵//wait for ack #
Set Beam Strength Output(Off) ↵//wait for ack #
Set Std Dev Speed Output(Off) ↵//wait for ack #
Set Std Dev Beam Speed Output(Off) ↵//wait for ack #
Set Cross Difference Output(Off) ↵//wait for ack #
Set Correlation Factor Output(Off) ↵//wait for ack #
Set Noise Level Output(Off) ↵//wait for ack #
Set Heading Output(Off) ↵//wait for ack #
Set Pitch Roll Output(Off) ↵//wait for ack #
Set Abs Tilt Output(Off) ↵//wait for ack #
Set Max Tilt Output(Off) ↵//wait for ack #
Set Tilt Direction Output(Off) ↵//wait for ack #
Set Std Dev Heading Output(Off) ↵//wait for ack #
Set Std Dev Tilt Output(Off) ↵//wait for ack #
Set Charge Voltage Output(Off) ↵//wait for ack #
Set Memory Used Output(Off) ↵//wait for ack #
Set Voltage Output(Off) ↵//wait for ack #
Set Current Output(Off) ↵//wait for ack #
Set Air Detect Output(Off) ↵//wait for ack #
Set Speed Of Sound Output(Off) ↵//wait for ack #
Set Depth Output(Off) ↵//wait for ack #
Set Salinity Output(Off) ↵//wait for ack #
Set Density Output(Off) ↵//wait for ack #
Do Refresh()↵
Set Interval(10 sec) ↵
Save ↵// wait for ack #
Reset ↵// the sensor will restart with new settings
```

Comments example 3:

The sensor always outputs some information which is not possible to disable. In this example only 1 cell is enabled just to show the shortest possible output first, see [Figure 5-7](#).

```

File Edit Setup Control Window Help
%
StartupInfo 5400 43 Mode AADI Smart Sensor Terminal Protocol RS232 Protocol Version 3 Config Version 49
Initializing...
Started...
MEASUREMENT 5400 43 Record State 524289 Ping Count 800 Cell Index 1000 Cell State1 6384 Cell State2 -241
Horizontal Speed[m/s] 38.13 Direction[Deg.M] 34.19
    
```

Figure 5-7: Example of the shortest output possible

The data output message starts with MEASUREMENT followed by **Product Number**, **Serial Number** (tabulator between). The rest of the message is the output parameters which change from record to record. First there is a **Record State** which gives information about different quality parameters per record and then ping count per record. After this comes all the profile data. The **Cell Index** gives information about the column and cell number. Column 1 starts with cell index 1000, column 2 with 2000 and column 3 with 3000. The highest cell index in column 1 is 1074 (cell 0 to 74), in column 2 it is 2049 (cell 0 to 49) and in column 3 it is 3024 (cell 0 to 24). If the surface cell is enabled a cell index 0 is also shown (treated as a column with 1 cell). **Cell State 1** and **Cell State 2** gives information about the data quality in each cell. **Horizontal Speed** and **Direction** is the minimum output from each cell.

The parameter names and values are separated by tabulator (ASCII code 09).

Example 4: Even more compact output, text off and decimal format

```

//Press Enter to start communicating with the sensor.
↵ //press Enter
Stop ↵ // Stop current measurement. Wait for ack #. Repeat if necessary.
Set Passkey(1) ↵ //wait for ack #
Set Enable Text(No) ↵ //wait for ack #
Set Enable Decimalformat(Yes) ↵ //wait for ack #
Save ↵ // wait for ack #
Reset ↵ // the sensor will restart with new settings
    
```

When you turn off text you also turn off the **StartupInfo** so this example gives an output without start up message and the parameter names also disappears; refer **Figure 5-8**.

```

File Edit Setup Control Window Help
%
StartupInfo 5400 43 Mode AADI Smart Sensor Terminal Protocol RS232 Protocol Version 3 Config Version 49
Initializing...
Started...
s!stop
#
set passkey(1)
#
set enable text(no)
#
set enable decimalformat(yes)
#
save
#
reset
#
%5400 43 524289 800 1000 4336 -241 8.52 126.66
5400 43 524289 800 1000 5616 -241 20.31 160.40
5400 43 524289 800 1000 5360 -241 19.38 155.47
    
```

Figure 5-8: Example of output message with text off and decimal format

5.7 Output parameters

5.7.1 Parameters outside profile data

These data are output first before the parameters from all cells in the columns. The name with unit shown in the table 3-2 is the exact same way as these are sent from the sensor, i.e. parameter name with unit in [] parentheses. The parameter name and the value output are separated by a tabulator (ASCII code 09). The output is a long string terminated by carriage return + line feed after all the profile data at the end.

Table 5-2: Sensor parameter details and explanation outside profile data

Name with unit	Type	Explanation
Heading[Deg.M]	Float	Averaged heading from one interval, one heading measurement per ping, vector averaged.
Std Dev Heading[Deg.M]	Float	Standard deviation calculation on all heading values from one interval. Indicates how much the sensor rotates around the vertical axis during a measurement interval.
Pitch[Deg]	Float	Pitch angle, average from one interval, one tilt measurement per ping. Pitch is the rotation angle around the x-axis of the sensor (same axis as Transducer 1 and 3)
Roll[Deg]	Float	Roll angle, average from one interval, one tilt measurement per ping. Roll is the rotation angle around the y-axis of the sensor (same axis as transducer 4 and 2)
Abs Tilt[Deg]	Float	Angle between sensor plane and horizontal plane. Calculates one value per ping from pitch and roll angles, average of all values.
Max Tilt[Deg]	Float	Maximum absolute tilt from the interval
Std Dev Tilt[Deg]	Float	Standard deviation tilt from all values of the absolute tilt in the interval. Indicates if the sensor is moving around with variable tilt during the measurement interval.
Tilt Direction[Deg.M]	Float	A tilt direction is calculated per ping, this is the average from the interval. Gives the direction where the sensor has its largest tilt, with magnetic north as reference.
Speed Of Sound[m/s]	Float	Either the fixed input setting or the derived sound speed (from other settings), averaged. ¹⁾
Depth[m]	Float	Depth calculated from input settings, averaged. ¹⁾
Salinity[PSU]	Float	Same as input setting. In AiCaP on SeaGuardII this can be calculated from Conductivity, Temperature and Pressure sensor inputs. ¹⁾
Density[kg/m ³]	Float	Calculated from Temperature, Pressure and Conductivity. In AiCaP on SeaGuardII this can be calculated from sensor inputs. ¹⁾
Charge Voltage Vtx1[V]	Float	The measured voltage to the capacitor on transmitter electronics to Transducer 1 and 2. It should normally be >4.8V.
Charge Voltage Vtx2[V]	Float	The measured voltage to the capacitor on transmitter electronics to Transducer 3 and 4. It should normally be >4.8V
Min Input Voltage[V]	Float	The minimum input voltage measured while charging the capacitor bank. It should normally be >6.0V
Input Current[mA]	Float	The current measured when not charging while awake, averaged.
Memory Used[Bytes]	Integer	Used heap memory.

Air Detect	Integer	Gives the raw value measured by the air detect sensor. The air detect function disables the ping pulse from the transducers (if the value is below the Air detect Threshold value). Only available on DCPS 5400, not on 5402 and 5403.
Record State	Integer	A 32-bit status number which provides quality warnings.
Ping Count	Integer	Number of pings executed, can be lower than configured number of pings to be done.

¹⁾ The sensor has input settings for Sound Speed (m/s), Air Pressure (kPa), Local Gravity Constant (m/s²), Salinity (PSU), Fixed Installation Pressure (kPa) and Temperature (Deg.C). When the sensor is used in AiCaP mode on a SeaGuardII or SmartGuard the sensor can receive sensor input from other sensors to calculate Density, Depth, Salinity and Sound Speed in water (CTD input data). Without an Aanderaa SeaGuardII or SmartGuard the user has to send down the new settings to be able to get surface referred columns and surface cell. Usually the salinity does not change much during a short time period. This is normally the case for Temperature also (the DCPS5400 can also be ordered with its own temperature 4080). The Air Pressure and Fixed Installation Pressure can for example be sent to the sensor more often to make the sensor able to calculate its own depth used for correct surface positioning/referencing.

Example 5: The parameters outside the profile data

```
//Press Enter to start communicating with the sensor ↵ //press Enter
Stop ↵ // Stop current measurement. Wait for ack #. Repeat if necessary.
Set Heading Output(Output) ↵ //wait for ack #
Set Pitch Roll Output(Output) ↵ //wait for ack #
Set Abs Tilt Output(Output) ↵ //wait for ack #
Set Max Tilt Output(Output) ↵ //wait for ack #
Set Tilt Direction Output(Output) ↵ //wait for ack #
Set Noise Level Output(Output) ↵ //wait for ack #
Set Std Dev Heading Output(Output) ↵ //wait for ack #
Set Std Dev Tilt Output(Output) ↵ //wait for ack #
Set Charge Voltage Output(Output) ↵ //wait for ack #
Set Memory Used Output(Output) ↵ //wait for ack #
Set Voltage Output(Output) ↵ //wait for ack #
Set Current Output(Output) ↵ //wait for ack #
Set Air Detect Output(Output) ↵ //wait for ack #
Set Speed Of Sound Output(Output) ↵ //wait for ack #
Set Depth Output(Output) ↵ //wait for ack #
Set Salinity Output(Output) ↵ //wait for ack #
Set Density Output(Output) ↵ //wait for ack #
Set Enable Text(Yes) ↵ //wait for ack #, text on again to see the parameter names
Set Enable Decimalformat(No) ↵ //wait for ack #, back to scientific numbers
Save ↵ // wait for ack #
Reset ↵ // the sensor will restart with new settings
```

The output string with all parameters outside the columns enabled and only one cell activated from example 5 is shown in **Figure 5-9**.

```

File Edit Setup Control Window Help
%
StartupInfo 5400 43 Mode AADI Smart Sensor Terminal Protocol RS232 Protocol Version 3 Config Version 49
Initializing...
Started...
MEASUREMENT 5400 43 Heading[Deg.M] 2.443495E+00 Std Dev Heading[Deg.M] 1.458520E+00 Pitch[Deg] 2.148229E+00 Roll[Deg] 1.787586E+02
Abs Tilt[Deg] 1.775105E+02 Max Tilt[Deg] 3.171875E+00 Std Dev Tilt[Deg] 1.158569E-01 Tilt Direction[Deg] 2.089789E+02 Speed Of Sound[m/s]
1.500000E+03 Depth[m] 4.966474E+01 Salinity[PSU] 3.500000E+01 Density[kg/m^3] 1.028067E+03 Charge Voltage Vtx1[V] 4.959045E+00 Charge Voltage
Vtx2[V] 4.973602E+00 Min Input Voltage[V] 7.443750E+00 Input Voltage[V] 7.770000E+00 Input Current[mA] 6.495000E+01 Memory Used[Bytes]
468196 Air Detect[LSB] 396 Record State 524289 Ping Count 150 Cell Index 1000 Cell State1 6384 Cell State2 -241 Horizontal Spee
d[cm/s] 6.747147E+01 Direction[Deg.M] 8.893159E+01
    
```

Figure 5-9: All parameters output outside profile data

The order of these parameters is as follows:

Heading, Std Dev Heading, Pitch, Roll, Abs Tilt, Max Tilt, Std Dev Tilt, Tilt Direction, Speed of Sound, Depth, Salinity, Density, Charge Voltage Vtx1, Charge Voltage Vtx2, Min Input Voltage, Input voltage, Input Current, Memory Used, Air Detect. Then the **Record State** and **Ping Count** are the last parameters before the first cell parameter in the first column is output.

5.7.2 Record State

A record state value is also output for each measurement interval. This is a 32-bit value where each bit has a status as shown in **Table 5-3**.

To analyse this value you need to convert the digital number to a binary number and then read the individual bit that is set. For example if **Record State** is 524289 like in **Figure 5-9** then the corresponding bit pattern is 0010000000000000000001 which means that bit 0 and bit 19 is set. If we then check this bits in **Table 5-3** we see that bit 0 indicate that the orientation set in configuration, **Upside Down** disabled does not match with the orientation measured by the sensor. Bit 19 indicates that the sensor is pinging in air.

Table 5-3: Record State parameter explained;

Record State bits		Meaning
Bit no	Bit pattern (x don't care)	
Bit 0	xxxxxxxxxxxxxxxxxxxxxxxxxxxxxxxx1	Orientation mismatch, configuration vs measurement ¹⁾
Bit 1	xxxxxxxxxxxxxxxxxxxxxxxxxxxxxxxx1x	High ambient noise measured on Beam 1 ²⁾
Bit 2	xxxxxxxxxxxxxxxxxxxxxxxxxxxxxxxx1xx	Higher ambient noise measured on Beam 1 ²⁾
Bit 1,2	xxxxxxxxxxxxxxxxxxxxxxxxxxxxxxxx11x	Even higher ambient noise measured on Beam 1 ²⁾
Bit 3	xxxxxxxxxxxxxxxxxxxxxxxxxxxxxxxx1xxx	High ambient noise measured on Beam 2 ³⁾
Bit 4	xxxxxxxxxxxxxxxxxxxxxxxxxxxxxxxx1xxxx	Higher ambient noise measured on Beam 2 ³⁾
Bit 3,4	xxxxxxxxxxxxxxxxxxxxxxxxxxxxxxxx11xxx	Even higher ambient noise measured on Beam 2 ³⁾
Bit 5	xxxxxxxxxxxxxxxxxxxxxxxxxxxxxxxx1xxxxx	High ambient noise measured on Beam 3 ⁴⁾
Bit 6	xxxxxxxxxxxxxxxxxxxxxxxxxxxxxxxx1xxxxxx	Higher ambient noise measured on Beam 3 ⁴⁾
Bit 5,6	xxxxxxxxxxxxxxxxxxxxxxxxxxxxxxxx11xxxxx	Even higher ambient noise measured on Beam 3 ⁴⁾
Bit 7	xxxxxxxxxxxxxxxxxxxxxxxxxxxxxxxx1xxxxxxx	High ambient noise measured on Beam 4 ⁵⁾

Bit 8	xxxxxxxxxxxxxxxxxxxx1xxxxxxx	Higher ambient noise measured on Beam 4 ⁵⁾
Bit 7,8	xxxxxxxxxxxxxxxxxxxx11xxxxxxx	Even higher ambient noise measured on Beam 4 ⁵⁾
Bit 9	xxxxxxxxxxxxxxxxxxxx1xxxxxxx	High standard deviation heading ⁶⁾
Bit 10	xxxxxxxxxxxxxxxxxxxx1xxxxxxx	Higher standard deviation heading ⁶⁾
Bit 9,10	xxxxxxxxxxxxxxxxxxxx11xxxxxxx	Even higher standard deviation heading ⁶⁾
Bit 11	xxxxxxxxxxxxxxxxxxxx1xxxxxxx	High standard deviation tilt ⁷⁾
Bit 12	xxxxxxxxxxxxxxxxxxxx1xxxxxxx	Higher standard deviation tilt ⁷⁾
Bit 11,12	xxxxxxxxxxxxxxxxxxxx11xxxxxxx	Even higher standard deviation tilt ⁷⁾
Bit 13	xxxxxxxxxxxxxxxxxxxx1xxxxxxx	Low input voltage, set if voltage below 6V
Bit 14	xxxxxxxxxxxxxxxxxxxx1xxxxxxx	High input voltage, set if voltage above 28V
Bit 15	xxxxxxxxxxxxxxxxxxxx1xxxxxxx	High input current, set if current above 300mA
Bit 16	xxxxxxxxxxxxxxxxxxxx1xxxxxxx	Low Vtx1 voltage detected, set if Vtx1 below 4.8V
Bit 17	xxxxxxxxxxxxxxxxxxxx1xxxxxxx	Low Vtx2 voltage detected, set if Vtx2 below 4.8V
Bit 18	xxxxxxxxxxxx1xxxxxxxxxxxxxxx	Low heap memory detected ⁸⁾
Bit 19	xxxxxxxxxxxx1xxxxxxxxxxxxxxx	Sensor is in air, set when in air if air detection is active ⁹⁾
Bit 20	xxxxxxxxxx1xxxxxxxxxxxxxxx	Upside down surface mismatch reference mismatch ¹⁰⁾
Bit 21	xxxxxxxxxx1xxxxxxxxxxxxxxx	Upside down surface cell mismatch ¹¹⁾

- 1) The upside down selection does not correspond to the actual orientation detected by the sensor.
- 2) The sensor measures the signal level on Beam 1 before pinging. This can indicate that another acoustic transmitter is sending out a sound signal nearby in the water (for example an echo sounder on a boat/ship). The noise level on Beam1 is indicated by two bits, bit 1 and 2, which gives three level indications. If bit1 is set, the noise is above -48dB. If bit 2 is set the level is above -38dB and if both are set the level is above -28dB.
- 3) Same levels as for Beam1 but here bit 3 and 4 indicates the three noise levels.
- 4) Same levels as for Beam1,2 but here bit 5 and 6 indicates the three noise levels.
- 5) Same levels as for Beam1,2,3 but here bit 7 and 8 indicates the three noise levels.
- 6) Bit 9 and 10 indicates if the standard deviation for heading is above limit 1, limit 2 or limit 3. Limit 1 is 10°, limit 2 is 20° and limit 3 is 30° standard deviation on heading.
- 7) Bit 11 and 12 indicates if the standard deviation for tilt is above limit 1, limit 2 or limit 3. Limit 1 is 10°, limit 2 is 20° and limit 3 is 30° standard deviation on absolute tilt.
- 8) The internal software allocates memory for variables and objects. Software bugs may cause memory leakage which again gives less and less room on the heap.
- 9) Factory enabled setting to detect if the sensor is in air (only used with 5400 and 5400R).
- 10) The combination of upside down and surface reference is not allowed (still possible to set both in Real Time Collector and from a Terminal program). This mismatch is indicated by this bit. A surface referred column is forced to be sensor referred if the sensor is placed upside down.

The combination of upside down and surface cell is not allowed (still possible to set both in Real Time Collector and from a Terminal program). This mismatch is indicated by this bit. The surface cell data is also set as not valid.

5.7.3 Cell Parameters

All Cells have the same number of parameters; the parameters shown in [Table 5-4](#) are repeated for each cell. The sensor can output from 1 cell in 1 column up to 150 cells total divided over three columns (75 in column 1, 50 in column 2 and 25 in column 3).

Table 5-4: Profile parameters details

Cell parameter with unit	Type	Description
Cell index	Int	An index which gives column and cell number. A 1xxx is column 1, 2xxx is column 2 and 3xxx is column 3. The cell index in column 1 is in the range from 1000-1074 dependent on number of cells, column 2 is 2000-2049 and column 3 is 3000-3024. The surface cell has a cell index 0. This index is only shown in Smart Sensor Terminal mode. The xml-output in the other modes (AiCaP and AADI Real-Time) gives profile data with separate column and cell index.
Cell State1	Int	The cell state 1 indicates different conditions like for example if the cell has weak signal or cell is inside blanking zone or illegible zone. If zero, everything is ok. See Table 5-6 for explanation.
Cell State 2	Int	The cell state 2 is an addition to cell state 1 and indicates different conditions on beam level like for example beam 1, beam 2, beam 3 or beam 4 is inside blanking zone or illegible zone. If zero, everything is ok. See Table 5-7 for explanation.
Horizontal Speed[cm/s]	Float	Horizontal speed calculated from the 4 beams and compensated for tilt, average of all pings over the interval duration. If the <i>AutoBeam Output</i> is enabled and the <i>AutoBeam Speed Type</i> is set to <i>Replace 4-Beam Data</i> , the autobeam algorithm output is used instead of the 4-beam solution (available from software version 8.2.1)
Direction[Deg.M]	Float	The current direction calculated from the 4 beams combined with compass heading to determine the current direction. If the <i>AutoBeam Output</i> is enabled and the <i>AutoBeam Speed Type</i> is set to <i>Replace 4-Beam Data</i> , the autobeam algorithm output is used instead of the 4-beam solution (available from software version 8.2.1)
North Speed[cm/s]	Float	North speed component, average of all pings over the recording interval.
East Speed[cm/s]	Float	East speed component, average of all pings over the recording interval.
Vertical Speed[cm/s]	Float	Vertical speed component, average of all pings over the recording interval.
Sp Stdev Horizontal[cm/s]	Float	Single ping standard deviation is the standard deviation calculated from all horizontal speed data in the interval.
Sp Stdev Beam123[cm/s]	Float	Standard deviation for the horizontal speed data calculated from the 3-beam combination of beam 1, 2 and 3. ³⁾
Sp Stdev Beam124[cm/s]	Float	Standard deviation for the horizontal speed data calculated from the 3-beam combination of beam 1, 2 and 4. ³⁾
Sp Stdev Beam134[cm/s]	Float	Standard deviation for the horizontal speed data calculated from the 3-beam combination of beam 1, 3 and 4. ³⁾
Sp Stdev Beam234[cm/s]	Float	Standard deviation for the horizontal speed data calculated from the 3-beam combination of beam 2, 3 and 4. ³⁾
SpStdev AutoBeam[cm/s]	Float	Standard deviation calculated using the Autobeam algorithm for horizontal speed data. ⁴⁾

Strength[dB]	Float	Averaged signal from the four beams. The signal strength is calculated for each beam for each ping and averaged at the end of the interval.
Horizontal Speed AutoBeam [cm/s]	Float	Horizontal speed from the Autobeam solution. The best data found automatically from the different beam solutions. Introduced from software version 8.2.1
Direction AutoBeam[Deg.M]		The current direction calculated from the 4 beams combined with compass heading to determine the current direction. Introduced from software version 8.2.1
North Beam123[cm/s]	Float	Averaged North speed based on a 3-beam solution from beam 1,2,3
North Beam124[cm/s]	Float	Averaged North speed based on a 3-beam solution from beam 1,2,4
North Beam134[cm/s]	Float	Averaged North speed based on a 3-beam solution from beam 1,3,4
North Beam234[cm/s]	Float	Averaged North speed based on a 3-beam solution from beam 2,3,4
North AutoBeam[cm/s]	Float	North speed from the Autobeam solution. The best data found automatically from the different beam solutions.
East Beam123[cm/s]	Float	Averaged East speed based on a 3-beam solution from beam 1,2,3
East Beam124[cm/s]	Float	Averaged East speed based on a 3-beam solution from beam 1,2,4
East Beam134[cm/s]	Float	Averaged East speed based on a 3-beam solution from beam 1,3,4
East Beam234[cm/s]	Float	Averaged East speed based on a 3-beam solution from beam 2,3,4
East AutoBeam[cm/s]	Float	East speed from the Autobeam solution. The best data found automatically from the different beam solutions.
Vertical Beam123[cm/s]	Float	Averaged Vertical speed based on a 3-beam solution from beam 1,2,3
Vertical Beam124[cm/s]	Float	Averaged Vertical speed based on a 3-beam solution from beam 1,2,4
Vertical Beam134[cm/s]	Float	Averaged Vertical speed based on a 3-beam solution from beam 1,3,4
Vertical Beam234[cm/s]	Float	Averaged Vertical speed based on a 3-beam solution from beam 2,3,4
Vertical AutoBeam[cm/s]	Float	Vertical speed from the Autobeam solution. The best data found automatically from the different beam solutions.
Beam1 Speed[cm/s]	Float	Averaged speed for beam 1.
Beam2 Speed[cm/s]	Float	Averaged speed for beam 2.
Beam3 Speed[cm/s]	Float	Averaged Speed for beam 3.
Beam4 Speed[cm/s]	Float	Averaged Speed for beam 4.
Beam1 Strength[dB]	Float	Averaged strength for beam 1.
Beam2 Strength[dB]	Float	Averaged strength for beam 2.
Beam3 Strength[dB]	Float	Averaged strength for beam 3.
Beam4 Strength[dB]	Float	Averaged strength for beam 4.
Beam1 Stdev[cm/s]	Float	Standard deviation calculated from all the beam 1 speeds in the interval.
Beam2 Stdev[cm/s]	Float	Standard deviation calculated from all the beam 2 speeds in the interval.
Beam3 Stdev[cm/s]	Float	Standard deviation calculated from all the beam 3 speeds in the interval.
Beam4 Stdev[cm/s]	Float	Standard deviation calculated from all the beam 4 speeds in the interval.

Cross Difference[cm/s]	Float	Calculated as (Beam1 Speed + Beam 3 Speed)-(Beam2 Speed+ Beam4 Speed) where the BeamX speeds are tilt compensated. The Cross Difference is calculated for each ping and averaged at the end of the interval. In a homogeneous water flow this value is close to zero.
Beam1 Correlation Factor[cm/s]	Float	In broadband mode only, this gives an indication of the quality of the speed data from beam1. The correlation factor should be close to 0.5
Beam2 Correlation Factor[cm/s]	Float	In broadband mode only, this gives an indication of the quality of the speed data from beam2. The correlation factor should be close to 0.5
Beam3 Correlation Factor[cm/s]	Float	In broadband mode only, this gives an indication of the quality of the speed data from beam3. The correlation factor should be close to 0.5
Beam4 Correlation Factor[cm/s]	Float	In broadband mode only, this gives an indication of the quality of the speed data from beam4. The correlation factor should be close to 0.5

The order of the output parameters from the sensor can change. The correct order can be found by sending the *Get Dataxml* command to the sensor. The configuration properties can be seen by sending a *Get All command* or a *Get Configxml* command to the sensor.

Table 5-5: Commands and Properties for enabling/disabling of Cell Parameters

Cell parameter with unit	How to disable/enable output
Cell index	Always on. Not possible to disable.
Cell Status	Always on. Not possible to disable.
Horizontal Speed[cm/s]	Always on. Not possible to disable. This is the 4-Beam solution but it might be overwritten if the AutoBeam algorithm is enabled.
Direction[Deg.M]	Always on. Not possible to disable.
North Speed[cm/s]	Set NE Speed Output(Off/Output)
East Speed[cm/s]	Set NE Speed Output(Off/Output)
Vertical Speed[cm/s]	Set Vertical Speed Output(Off/Output)
Sp Stdev Horizontal[cm/s]	Set Std Dev Speed Output(Off/Output).
Sp Stdev Beam123[cm/s]	Set 3-Beam Combination Output (Off/Output) and Set NE Speed Output(Off/Output) (both set to output to be enabled). This is changed from software version 8.2.1. From this version only Set 3-Beam Combination Output(Off/Output) affects the output of this parameter
Sp Stdev Beam124[cm/s]	Set 3-Beam Combination Output (Off/Output) and Set NE Speed Output(Off/Output) (both set to output to be enabled). This is changed from software version 8.2.1. From this version only Set 3-Beam Combination Output(Off/Output) affects the output of this parameter
Sp Stdev Beam134[cm/s]	Set 3-Beam Combination Output (Off/Output) and Set NE Speed Output(Off/Output) (both set to output to be enabled). This is changed from software version 8.2.1. From this version only Set 3-Beam Combination Output(Off/Output) affects the output of this parameter
Sp Stdev Beam234[cm/s]	Set 3-Beam Combination Output (Off/Output) and Set NE Speed Output(Off/Output) (both set to output to be enabled). This is changed from software version 8.2.1. From this version only Set 3-Beam Combination Output(Off/Output) affects the output of this parameter

SpStdev AutoBeam[cm/s]	Set AutoBeam Output(Off/Output) and Set NE Speed Output(Off/Output) (both set to output to be enabled). From software version 8.2.1: Set AutoBeam Output(Off/Output) together with Set Std Dev Speed Output(Off/Output)
Strength[dB]	Set Strength Output(Off/Output)
Horizontal Speed AutoBeam [cm/s]	Set AutoBeam Output(Off/Output) and Set AutoBeam Speed Type(Polar/Rectangular/Polar+Rectangular/Replace 4-Beam Data) set to Output and Polar to be enabled
Direction AutoBeam[Deg.M]	Set AutoBeam Output(Off/Output) and Set AutoBeam Speed Type(Polar/Rectangular/Polar+Rectangular/Replace 4-Beam Data) set to Output and Polar to be enabled
North Beam123[cm/s]	Set NE Speed Output(Off/Output) and Set 3-Beam Combination Output(Off/Output) (both set to output to be enabled). This is changed from software version 8.2.1. From this version only Set 3-Beam Combination Output(Off/Output) affects the output of this parameter
North Beam124[cm/s]	Set NE Speed Output(Off/Output) and Set 3-Beam Combination Output(Off/Output) (both set to output to be enabled). This is changed from software version 8.2.1. From this version only Set 3-Beam Combination Output(Off/Output) affects the output of this parameter
North Beam134[cm/s]	Set NE Speed Output(Off/Output) and Set 3-Beam Combination Output(Off/Output) (both set to output to be enabled). This is changed from software version 8.2.1. From this version only Set 3-Beam Combination Output(Off/Output) affects the output of this parameter
North Beam234[cm/s]	Set NE Speed Output(Off/Output) and Set 3-Beam Combination Output(Off/Output) (both set to output to be enabled). This is changed from software version 8.2.1. From this version only Set 3-Beam Combination Output(Off/Output) affects the output of this parameter
North AutoBeam[cm/s]	Set NE Speed Output(Off/Output) and Set AutoBeam Output(Off/Output) From software version 8.2.1: Set AutoBeam Speed Type(Polar/Rectangular/Polar+Rectangular/ Replace 4-Beam Data) and Set AutoBeam Output(Off/Output) set to Rectangular and Output to be enabled
East Beam123[cm/s]	Set NE Speed Output(Off/Output) and Set 3-Beam Combination Output(Off/Output) (both set to output to be enabled). This is changed from software version 8.2.1. From this version only Set 3-Beam Combination Output(Off/Output) affects the output of this parameter
East Beam124[cm/s]	Set NE Speed Output(Off/Output) and Set 3-Beam Combination Output(Off/Output) (both set to output to be enabled). This is changed from software version 8.2.1. From this version only Set 3-Beam Combination Output(Off/Output) affects the output of this parameter
East Beam134[cm/s]	Set NE Speed Output(Off/Output) and Set 3-Beam Combination Output(Off/Output) (both set to output to be enabled). This is changed from software version 8.2.1. From this version only Set 3-Beam Combination Output(Off/Output) affects the output of this parameter
East Beam234[cm/s]	Set NE Speed Output(Off/Output) and Set 3-Beam Combination Output(Off/Output) (both set to output to be enabled). This is changed from software version 8.2.1. From this version only Set 3-Beam Combination Output(Off/Output) affects the output of this parameter

East AutoBeam[cm/s]	Set NE Speed Output(Off/Output) and Set AutoBeam Output(Off/Output) From software version 8.2.1:Set AutoBeam Speed Type(Polar/Rectangular/Polar+Rectangular/ Replace 4-Beam Data) and Set AutoBeam Output(Off/Output) set to Rectangular and Output to be enabled
Vertical Beam123[cm/s]	Set Vertical Speed Output(Off/Output) and Set 3-Beam Combination Output(Off/Output) (both set to output to be enabled). This is changed from software version 8.2.1. From this version only Set 3-Beam Combination Output(Off/Output) affects the output of this parameter
Vertical Beam124[cm/s]	Set Vertical Speed Output(Off/Output) and Set 3-Beam Combination Output(Off/Output) (both set to output to be enabled). This is changed from software version 8.2.1. From this version only Set 3-Beam Combination Output(Off/Output) affects the output of this parameter
Vertical Beam134[cm/s]	Set Vertical Speed Output(Off/Output) and Set 3-Beam Combination Output(Off/Output) (both set to output to be enabled). This is changed from software version 8.2.1. From this version only Set 3-Beam Combination Output(Off/Output) affects the output of this parameter
Vertical Beam234[cm/s]	Set Vertical Speed Output(Off/Output) and Set 3-Beam Combination Output(Off/Output) (both set to output to be enabled). This is changed from software version 8.2.1. From this version only Set 3-Beam Combination Output(Off/Output) affects the output of this parameter
Vertical AutoBeam[cm/s]	Set NE Speed Output(Off/Output) and Set AutoBeam Output(Off/Output) From software version 8.2.1: Set AutoBeam Output(Off/Output) and and Set Vertical Speed Output(Off/Output)
Beam1 Speed[cm/s]	Set Beam Speed Output(Off/Output)
Beam2 Speed[cm/s]	Set Beam Speed Output(Off/Output)
Beam3 Speed[cm/s]	Set Beam Speed Output(Off/Output)
Beam4 Speed[cm/s]	Set Beam Speed Output(Off/Output)
Beam1 Strength[dB]	Set Beam Strength Output(Off/Output)
Beam2 Strength[dB]	Set Beam Strength Output(Off/Output)
Beam3 Strength[dB]	Set Beam Strength Output(Off/Output)
Beam4 Strength[dB]	Set Beam Strength Output(Off/Output)
Beam1 Stdev[cm/s]	Set Std Dev Beam Speed Output(Off/Output)
Beam2 Stdev[cm/s]	Set Std Dev Beam Speed Output(Off/Output)
Beam3 Stdev[cm/s]	Set Std Dev Beam Speed Output(Off/Output)
Beam4 Stdev[cm/s]	Set Std Dev Beam Speed Output(Off/Output)
Cross Difference[cm/s]	Set Cross Difference Output(Off/Output)
Beam1 Correlation Factor[cm/s]	Set Bandwidth(Broadband) Set Correlation Factor Output(Off/Output)
Beam2 Correlation Factor[cm/s]	Set Bandwidth(Broadband) Set Correlation Factor Output(Off/Output)
Beam3 Correlation Factor[cm/s]	Set Bandwidth(Broadband) Set Correlation Factor Output(Off/Output)
Beam4 Correlation Factor[cm/s]	Set Bandwidth(Broadband) Set Correlation Factor Output(Off/Output)

5.7.4 Cell States

A **Cell State 1** and **Cell State 2** is output for each cell giving QC data for each cell. Each bit has a status as shown in **Table 5-6** and **Table 5-7**.

To analyse this value you need to convert the digital number to a binary number end then read the individual bit that is set. For example if **Cell State 1** is 6384 like in **Figure 5-9** then the corresponding bit pattern is 110001111000 which means that bit 4,5,6,7,11 and bit 12 is set. If we then check these bits in **Table 5-6** we see that bit 4 and 5 indicate that the Cell has weak signal, strength below weak strength limit 3, and default value -48dB. Bit 6 and 7 indicates that Cell has High standard deviation, above SP standard deviation 3 limits. Bit 11 indicates that Cell has High vertical current, above high vertical limit 2, default 20 cm/s and bit 12 indicates that Cell is setup to measure inside blanking zone.

Table 5-6: Cell State1 (For SW version 8.3.6. and newer. For older version see previous version.)

Cell State1 bits		Meaning
Bit no	Bit pattern (x don't care)	
0	Binary: xxxxxxxxxxxxxx1 Hexadecimal: xxx1	High broadband cross correlation beam1, above cross correlation high limit ¹⁾
1	Binary: xxxxxxxxxxxxxx1x Hexadecimal: xxx2	High broadband cross correlation beam2, above cross correlation high limit ¹⁾
2	Binary: xxxxxxxxxxxxxx1xx Hexadecimal: xxx4	High broadband cross correlation beam3, above cross correlation high limit ¹⁾
3	Binary: xxxxxxxxxxxxxx1xxx Hexadecimal: xxx8	High broadband cross correlation beam4, above cross correlation high limit ¹⁾
4	Binary: xxxxxxxxxxx1xxxx Hexadecimal: xx1x	Cell has Weak signal, strength below weak strength limit 1, default value -40dB
5	Binary: xxxxxxxxxxx1xxxxx Hexadecimal: xx2x	Cell has weak signal, strength below weak strength limit 2, default value -44dB
4 and 5	Binary: xxxxxxxxxxx11xxxx Hexadecimal: xx3x	Cell has weak signal, strength below weak strength limit 3, default value -48dB
6	Binary: xxxxxxxx1xxxxxx Hexadecimal: xx4x	Cell has High standard deviation, above SP standard deviation 1 limit ²⁾
7	Binary: xxxxxxxx1xxxxxxx Hexadecimal: xx8x	Cell has High standard deviation, above SP standard deviation 2 limit ²⁾
6 and 7	Binary: xxxxxxxx11xxxxxx Hexadecimal: xxCx	Cell has High standard deviation, above SP standard deviation 3 limit ²⁾
8	Binary: xxxxxxx1xxxxxxxx Hexadecimal: x1xx	Cell has High cross difference, above cross difference limit 1, ¹⁾ default 10 cm/s
9	Binary: xxxxxx1xxxxxxxxxx Hexadecimal: x2xx	Cell has High cross difference, above cross difference limit 2, default 25 cm/s
8 and 9	Binary: xxxxxx11xxxxxxxx Hexadecimal: x3xx	Cell has High cross difference, above cross difference limit 3, default 40 cm/s
10	Binary: xxxxx1xxxxxxxxxxx Hexadecimal: x4xx	Cell has High vertical current, above high vertical limit ,1 default 10 cm/s
11	Binary: xxxx1xxxxxxxxxxxx Hexadecimal: x8xx	Cell has High vertical current, above high vertical limit 2, default 20 cm/s

10 and 11	Binary: xxxx11xxxxxxxxxx Hexadecimal: xCxx	Cell has High vertical current, above high vertical limit 3, default 30 cm/s
12	Binary: xxx1xxxxxxxxxxxx Hexadecimal: 1xxx	Cell inside blanking zone ³⁾
13	Binary: xx1xxxxxxxxxxxx Hexadecimal: 2xxx	Cell inside illegible zone ⁴⁾
14	Binary: x1xxxxxxxxxxxx Hexadecimal: 4xxx	Cell out of range ⁵⁾
15	Binary: 1xxxxxxxxxxxx Hexadecimal: 8xxx	Data not ready

¹⁾ The cross correlation is normally close to 0.5, high limit is 0.6

²⁾ Indicates high single ping standard deviation on horizontal speed.. Narrowband and Broadband have different limits. The limit input is set as single ping standard deviation per meter since it is dependent on the cell size (and pulse length). The limits for Broadband are 10, 30 and 50 cm/s. The limits for narrowband are 60, 80 and 100 cm/s. These limits are used for a 1 meter cell (and pulse). The standard deviation limits used are calculated from these as follows, SP Stdev limit = SP Stdev per meter limit/sqrt(cellsize*pulselength). Broadband uses a fixed pulse length = 1m. In narrowband the pulse length follows the column with the smallest cell size. If for example narrowband with 2m cell size and 2m pulse length, the single ping standard deviation limits becomes 30, 40 and 50 cm/s.

³⁾ The cell can have been configured to be behind the instrument or very close to the instrument. This can also change during the deployment dependent on water level changes and sensor tilt.

⁴⁾ The illegible zone: if surfaced referred column, approximately 10% of the distance from surface to the instrument is contaminated by side lobes.

⁵⁾ Cells can have been configured to be too far away. Tilting of the instrument can also result in out of range on some of the beam cells.

Table 5-7: Cell State2 (For SW version 8.3.6. and newer. For older version see previous version.)

Cell State2 bits		Meaning
Bit no	Bit pattern (x don't care)	
0	Binary: xxxxxxxxxxxxxx1 Hexadecimal: xxx1	Beam1 cell inside blanking zone ¹⁾
1	Binary: xxxxxxxxxxxxxx1x Hexadecimal: xxx2	Beam2 cell inside blanking zone ¹⁾
2	Binary: xxxxxxxxxxxxxx1xx Hexadecimal: xxx4	Beam3 cell inside blanking zone ¹⁾
3	Binary: xxxxxxxxxxxxxx1xxx Hexadecimal: xxx8	Beam4 cell inside blanking zone ¹⁾
4	Binary: xxxxxxxxxxx1xxxx Hexadecimal: xx1x	Beam1 cell out of range (too far away) ²⁾

5	Binary: xxxxxxxxxx1xxxxx Hexadecimal: xx2x	Beam2 cell out of range (too far away) ²⁾
6	Binary: xxxxxxxxxx1xxxxxx Hexadecimal: xx4x	Beam3 cell out of range (too far away) ²⁾
7	Binary: xxxxxxxx1xxxxxxx Hexadecimal: xx8x	Beam4 cell out of range (too far away) ²⁾
8	Binary: xxxxxxxx1xxxxxxx Hexadecimal: x1xx	Beam 1 cell weak signal strength, below weak signal limit 1, <i>default value -40dB</i>
9	Binary: xxxxxx1xxxxxxxxx Hexadecimal: x2xx	Beam 1 cell weak signal strength, below weak signal limit 2, <i>default value -44dB</i>
8 and 9	Binary: xxxxxx11xxxxxxxxx Hexadecimal: x3xx	Beam 1 cell weak signal strength, below weak signal limit 3, <i>default value -48dB</i>
10	Binary: xxxxx1xxxxxxxxxxx Hexadecimal: x4xx	Beam 2 cell weak signal strength, below weak signal limit 1, <i>default value -40dB</i>
11	Binary: xxxx1xxxxxxxxxxx Hexadecimal: x8xx	Beam 2 cell weak signal strength, below weak signal limit 2, <i>default value -44dB</i>
10 and 11	Binary: xxxx11xxxxxxxxxxx Hexadecimal: xCxx	Beam 2 cell weak signal strength, below weak signal limit 3, <i>default value -48dB</i>
12	Binary: xxx1xxxxxxxxxxx Hexadecimal: 1xxx	Beam 3 cell weak signal strength, below weak signal limit 1, <i>default value -40dB</i>
13	Binary: xx1xxxxxxxxxxx Hexadecimal: 2xxx	Beam 3 cell weak signal strength, below weak signal limit 2, <i>default value -44dB</i>
12 and 13	Binary: xx11xxxxxxxxxxx Hexadecimal: 3xxx	Beam 3 cell weak signal strength, below weak signal limit 3, <i>default value -48dB</i>
14	Binary: x1xxxxxxxxxxx Hexadecimal: 4xxx	Beam 4 cell weak signal strength, below weak signal limit 1, <i>default value -40dB</i>
15	Binary: 1xxxxxxxxxxx Hexadecimal: 8xxx	Beam 4 cell weak signal strength, below weak signal limit 2, <i>default value -44dB</i>
14 and 15	Binary: 11xxxxxxxxxxx Hexadecimal: Cxxx	Beam 4 cell weak signal strength, below weak signal limit 3, <i>default value -48dB</i>

¹⁾ The cell can have been configured to be behind the instrument or very close to the instrument. This can also change during the deployment dependent on water level changes and sensor tilt.

²⁾ Cells can have been configured to be too far away. Tilting of the instrument can also result in out of range on some of the beam cells.

CHAPTER 6 Software versions and Stand-alone usage

The first software versions on the DCPS were made for use together with the SeaGuardII and SmartGuard Datalogger only. Using the sensor with a lower software version than 8.1.25 as a stand-alone sensor without a SeaGuard II or SmartGuard is not recommended and will not work properly.

Software versions below v8.1.27 have a different input on the Interval property and the Polled Pingrate property. These did not show up as enumerated types when sending the Help command to the sensor.

6.1 Interval and Polled pingrate settings on software version below 8.1.27

The minimum interval is limited dependent on the sensor configuration. The following values were accepted (number of seconds as input).

10, 20, 30, 60, 120, 180, 300, 360, 600, 900, 1200, 1800, 3600 or 7200

The maximum polled pingrate is limited dependent on the sensor configuration. The following values were accepted (Hz)

0.1, 0.5, 1, 2, 3, 4, 5, 6, 7, 8, 9, 10

6.2 Interval and Polled Pingrate from software version 8.1.27

The Help command gives the available settings for the Interval and the Polled Pingrate. The lowest Interval available and the highest Polled Pingrate available is limited. After configuration and a Do Refresh command the listing under will show only the values allowed.

The input for the interval is now as follows

10 sec, 20 sec, 30 sec, 1 min, 2 min, 3 min, 5 min, 6 min, 10 min, 15 min, 20 min, 30 min, 1 hour or 2 hour.

The input for the Polled Pingrate is as follows

0.1 Hz, 0.5 Hz, 1 Hz, 2 Hz, 3 Hz, 4 Hz, 5 Hz, 6 Hz, 7 Hz, 8 Hz, 9 Hz and 10 Hz

6.3 Enabling old input on software versions from 8.1.34

It is possible to enable the old input as it was before software version 8.1.27 (from sw version 8.1.34) doing as follows

```
//Press Enter to start communicating with the sensor, refer chapter Error! Reference source not found.
↵ //press Enter
Stop ↵ //Wait for ack #
Set Passkey(1000) ↵ //Wait for ack #
Set Enable Old Time Setting(Yes) ↵ //Wait for ack #
Save ↵ //Wait for ack #
Reset ↵
```

CHAPTER 7 Electro Magnetic Compatibility and Cables

In order for a manufacturer to legally produce and sell a product, it has to apply for CE marking. This means that the commercialized product is conform to the CE applicable standards and can freely circulate within the EFTA (European Free Trade Association) & European Union countries. The applicable directive for the Acoustic Doppler products is the EU EMC 89/336/EMC (all electrical and electronic appliances) which mainly focus on the electromagnetic disturbances the sensor can generate, which should not exceed a level allowing radio and telecommunication equipment to operate as intended, and that the sensor has an adequate level of intrinsic immunity to electromagnetic disturbance to be able to operate as intended. This chapter describes the requirements for the Electromagnetic Compatibility (EMC) of the sensor; EMC filter and protection solutions required for the Doppler Current Profiler Sensor. And also addresses the different cables available for use of the DCPS sensor.

7.1 EMC Filter and Protection

The sensor is designed to have an extremely high amplification in the Doppler frequency range around 600 kHz. This also means that severe common mode noise on the power lines may affect the Doppler measurements if the noise frequencies are close to 600 kHz. This can be checked from the signal strength and noise peak output when connected to the power of the system.

Two different options are delivered from the factory, one for underwater/buoy systems and one for cable to land systems.

7.1.1 Underwater/Buoy systems

A common mode line filter on the power lines has to be inserted between the sensor and the system. This filter should be as close as possible to the cable output from the system and the ground connection on the filter has to be connected to the common chassis ground of the system or a common ground structure. The chassis ground serves as a return path for noise currents decoupled by the common mode filter. This is necessary since the noise currents should have a low impedance path back to the noise source in the system.

This common mode filter may be left out if the system designer knows (from EMC emission tests) that the system does not emit any noise on the cable to the sensor in the range around 600 kHz.

7.1.2 Cable to land systems

A Filter Box with surge protection on all lines is delivered together with the cables. This box also has the same built in common mode filter as delivered for underwater systems. This box needs a good connection to earth to divert any large surge currents to earth. Cable screen from sea side cable and land side cable needs a good connection to the chassis of the box.

Surge current are generated from nearby lightning and can cause surge currents in the kilo-ampere range on a cable. The sensor has some protection built-in but the safest is to remove as much as possible of these large surge currents on the land side of the cable.

If using the SeaGuardII DCP with Real-Time cable to land, the same filter box is delivered together with the instrument and should be installed the same way. The operating manual for SeaGuardII, TD 303, gives more information on the available cables.

7.2 EMC Testing

The DCPS sensor has been tested at an accredited test laboratory to verify that the sensor fulfills the requirements in the EU EMC directive (89/336/EMC).

Applied standards

- EN55011 (2009)+A1
- EN 61326-1 (2013)

Applied tests

- Conducted Emissions
- Electrostatic Discharge Immunity
- Surge Immunity
- Conducted RF Disturbance Immunity

Other tests were found as not relevant to this sensor due to underwater use and DC power.

7.3 Cables

Different cables are available for stand-alone use with free end and connectors. The cables have both power and signal lines (RS-232/RS-422). Contact factory for more information on cables that is best suited for use in the actual application. When delivered, system drawings/cable drawings give details on parts connection and installation overview with best EMC performance (best noise and surge immunity).

In underwater and buoy systems the sensors are delivered with a common mode line filter to be used on the power lines. This is necessary to remove any present common mode noise frequencies in the Doppler frequency range.

In systems with cable to land the sensor is delivered with a Filter Protection box. This box has a common mode noise filter and surge protection on power lines and signal lines.

7.4 Power – Voltage range

The input voltage range is from 6 to 30Vdc. When using long cables the voltage should be as close to 30V as possible. The peak current while the sensor is pinging (after power on) is normally well below 1A (normally below 0.5A), but it varies dependent on how high the input voltage is and how large the voltage drop is in the cable (lower voltage on the sensor gives higher peak current).

CHAPTER 8 Acoustic Wave

8.1 General information

8.2 Parameter list

Table 8-1 Parameter list

Output parameters	Symbol	Type
Energy Spectrum	$E(f)$	Research
Directional Spectrum	$DWS_m(f)$	Research
Principal Directional Spectrum	$DWS_p(f)$	Research
Orbital Ratio Spectrum	$K(f)$	Research
Fourier Coefficients Spectrum	$A1(f), B1(f), A2(f), B2(f)$	Research
Wave Mean Direction	θ_{avg}	Operational
Significant Wave Height H_{m0}	H_{m0}	Operational
Significant Wave Height $H_{1/3}$	$H_{1/3}$	Operational
Wave Mean Period T_{m02}	T_{m02}	Operational
Wave Energy Period T_{m10}	T_{m10}	Operational

See description and calculation of all parameters in chapter 8.3.

8.3 Parameter calculation

The **Energy Spectrum, $E(f)$** gives the vertical wave energy density for each frequency bin, accumulated from all directions.

Fourier Coefficients Spectrum, $A1(f)$, $B1(f)$, $A2(f)$, $B2(f)$ are used to calculate all frequency based parameters.

Two different directional Spectrums are calculated

1. **Direction Spectrum, $DWS_m(f)$** is calculated as mean wave direction for each frequency bin in the spectrum based on the first order Fourier Coefficients.

$$\theta_1(f) = \text{atan}(b_1(f_i)/a_1(f_i))$$

2. **Principal Dir Spectrum, $DWS_p(f)$** is calculated based on the second order Fourier Coefficients. The principal wave direction has an ambiguity direction of 180 degree, but is forced to be in the same interval as the mean wave direction.

$$\theta_2(f) = 0.5 \cdot \text{atan}(b_2(f_i)/a_2(f_i))$$

Orbital Ratio Spectrum, $K(f)$ gives the ratio of vertical to horizontal motions corrected for the wavenumber and water depth

$$K(f) = \left\{ \frac{1}{\tanh(k(f) \cdot h)} \right\} \cdot \sqrt{\frac{C_{11}(f)}{C_{22}(f) + C_{33}(f)}}$$

where:

$C_{11}(f)$, $C_{22}(f)$, and $C_{33}(f)$, are the cross-spectra of displacement in Vertical, East and North direction. $k(f)$, is the wave number and h is the water depth.

Wave Mean Direction, θ_{avg} is the energy weighted mean direction over all frequency bins.

$$\theta_{avg} = \text{atan} \left(\sum_i E(f_i) \cdot b_1(f_i)/a_1(f_i) \right)$$

The spreading angle is a measure of how wide the directional cone is over which the wave direction is distributed (Kumar and Anoop, 2013).

Significant wave height is defined traditionally as the mean wave height (trough to crest) of the highest third of the waves ($H_{1/3}$). A modern definition of significant wave height is usually defined as four times the standard deviation of the surface elevation. The symbol H_{m0} is usually used for that latter definition. The significant wave height may thus refer to H_{m0} or $H_{1/3}$; the difference in magnitude between the two definitions is only a few percent.

Significant Wave Height, $H_{1/3}$ is the mean of the highest third of the waves in a time-series computed on the basis of a spectrum and is referred to as $H_{1/3}$.

Wave Mean Period, T_{m02} is the mean wave period calculated from the spectrum.

$$T_{m02} = \sqrt{\frac{m_2}{m_0}}$$

where:

m_n is the n order moment calculated from the Energy spectrum as;

$$m_n = \int_0^\infty f^n E(f) df$$

8.4 Other wave descriptions

Wave Crest is the point on a wave with the maximum value or upward displacement within a cycle

Wave Troughs is the point on a wave with the minimum or lowest point in a cycle

Wavelength is the distance from a certain point on one wave to the same point on the next wave (e.g. distance between two consecutive wave crests or between two consecutive wave troughs).

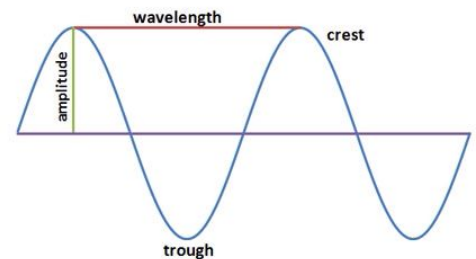

Figure 8-1: wave descriptions

Wave amplitude is one half the distances from the crest to the trough. Wave amplitude is a more technical term for wave height and is used in engineering technology.

Wave frequency is the number of waves passing a fixed point in a specified period of time. Frequency has units of waves per second or cycles per second. Another unit for frequency is the Hertz (abbreviated Hz) where 1 Hz is equivalent to 1 cycle per second.

Wave period are the time it takes for two successive crests (one wavelength) to pass a specified point.

Wave speed is the distance the wave travels divided by the time it takes to travel that distance. Wave speed is determined by dividing the wavelength by the wave period. In symbols $c = \lambda / T$, where c is the wave speed, λ (lambda) is the wavelength, and T is the period.

Wave Steepness is the ratio of height to wavelength. When wave steepness exceeds 1:7, breakers form. If a wave has height of one foot and a length from crest to crest of 8 feet, then the ratio is 1:8 and this wave is not going to break. But if the height is 1 foot and the length decreases to 5 feet, then the ratio is 1:5 and this wave has now become so steep that the crest topples and the wave breaks.

CHAPTER 9 Other details

9.1 Compass heading 0° reference direction

In some cases it is necessary to know the orientation of the sensor's axes. This can be necessary when the sensor is placed in a fixed position with a fixed orientation (for example in a frame on the sea floor) where the magnetic influence by an object nearby gives an erroneous heading measurement. In this case the fixed heading input can be enabled, but to set the correct fixed heading the 0° reference has to be known. On surface buoys made of iron/steel there can also be problems related to magnetic influence from the buoy structure/body. This can be improved by using an external compass (parameter input via SeaGuardII or SmartGuard Datalogger) placed away on a mast arm which gives a more correct compass heading to the sensor. In this case the misalignment/offset between the external compass and the axes on the DCPS has to be known.

9.1.1 Transducer 1 is 0° reference

When transducer 1 on the sensor is orientated towards magnetic North, the compass heading is 0°. One method is to measure in which direction transducer 1 is pointing. Position of transducer 1 is shown in [Figure 9-1](#). Moving transducer 1 clockwise gives an increasing heading.



- Find direction of magnetic north.
- Find x-axis on DCPS, axis with transducer 1 and 3 (opposite side on same axis).
- If a fixed and non-moving application, align x-axis and transducer 1 towards correct magnetic north. Alternatively measure the angle clockwise from magnetic north to x-axis transducer 1 and set the fixed heading equal to this value (degrees).
- If used on a buoy with external compass input, align the x-axis transducer 1 in the same direction as the north mark on the compass. Alternatively, try to measure the clockwise angle from the north mark (0 degree) on the external compass to the x-axis transducer 1 on the DCPS. Set the heading alignment offset equal to this measured angle (input parameter heading see [chapter 3.5.9](#)). Also remember to select the external compass as heading input to the DCPS.

Figure 9-1 Orientation transducer 1

NOTE: To check the value measured by the tilt and heading sensor refer to chapter 4.2. Viewing incoming data in real-time.

The same procedure can be used if the DCPS is orientated upside-down.

9.1.2 Orientation/Steering pin as reference

Another method is to use the orientation pin underneath the sensor. This pin is placed between transducer 2 and 3. The heading is 225 degrees (360-135) if the orientation pin is towards magnetic north, i.e. transducer 1 is 225 degree clockwise from the orientation pin. The positioning of the orientation pin is shown in the [Figure 9-2](#) and [Figure 9-3](#).

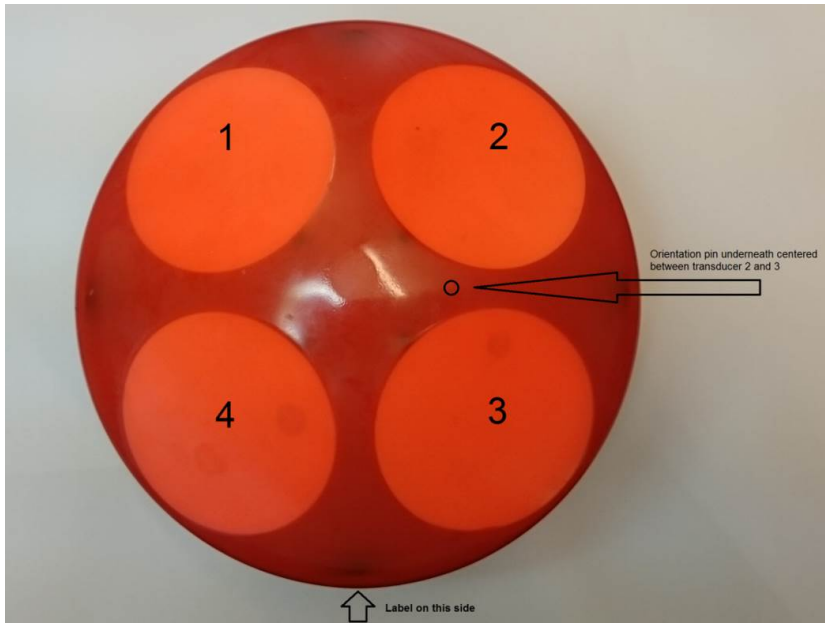

- Use the same methods as described in [chapter 9.1.1](#)
- Remember that the angle between transducer 1 and the steering/orientation pin is 225 degrees.
- Add 225 degrees to the measured orientation of this pin when used as fixed heading setting. If larger than 360, subtract 360 from the value.
- If external compass input, add 225 degrees to the angle measured between the external compass and the orientation pin. Set the heading alignment offset value equal to this value. If larger than 360, subtract 360 from the value.

Figure 9-2 Orientation pin and transducers

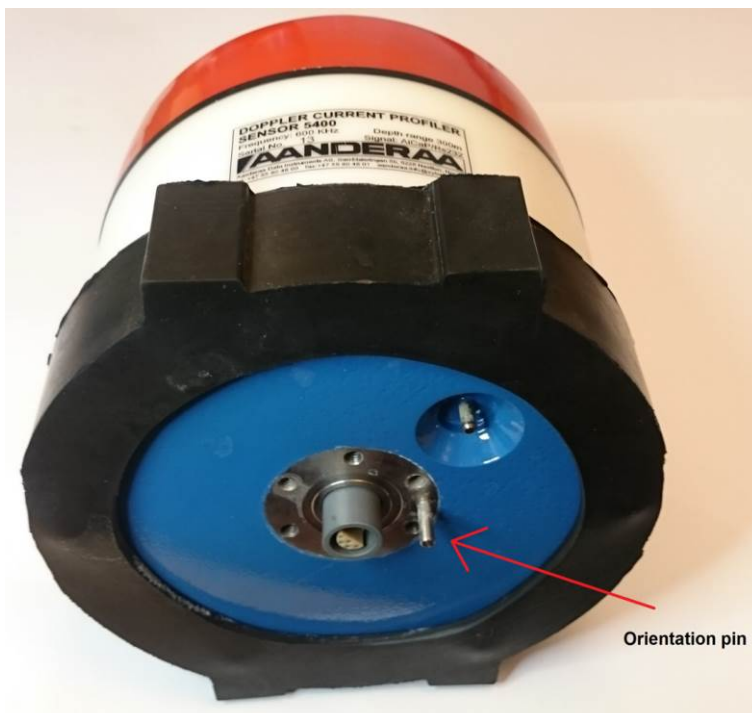

Figure 9-3 Orientation pin placement on end plate

9.1.3 Transducer 1 as reference when upside-down

Use the same method as when the sensor is upward looking. Rotating clockwise gives an increasing angle. The sensor is able to sense its vertical orientation sensor and automatically correct for the upside-down orientation of the sensor.

NOTE: To check the value measured by the tilt and heading sensor refer to chapter 4.2. Viewing incoming data in real-time.

9.1.4 Orientation/Steering pin as reference when upside-down

Now transducer 1 is 135 degrees clockwise from the orientation pin. Add 135 degrees instead of 225 degrees.

9.2 Checking the compass

First point transducer 1 towards North. The compass heading should lie close to $360^{\circ}/0^{\circ}$ (same point).

NOTE: To check the value measured by the tilt and heading sensor refer to chapter 4.2. Viewing incoming data in real-time.

A clockwise rotation gives an increasing compass angle. Keep the sensor away from magnetic object like table legs (if iron, these are acting as a permanent magnet magnetized by the earth magnetic field). Big objects like for example a car outside the room where the compass is tested can affect the earth magnetic field at the point where the sensor is placed. Also the structure of the building can influence on the earth magnetic field around the sensor.

Be aware that nearby objects may influence the magnetic field when the sensor is used. This can for example be a problem on a buoy as described above or if hanging from a boat. The rule of thumb is that the bigger the magnetic object is (hard and/or soft magnetic) the further away sensor should be positioned to eliminate the influence. If the sensor is in a fixed position the fixed heading input can be used as described earlier in this chapter. On buoys the solution is often to use an external compass which is placed on a non-magnetic mast away from the buoy.

Even alkaline batteries can be a problem if placed close enough to the sensor. When used on SeaGuardII the upper battery compartment can give problems when using alkaline battery cells. The battery cells provided by Aanderaa do not give problems when using the lower battery compartment. When batteries are own-built, you have to be aware of this problem. The influence from the batteries can be checked by looking at the heading output from the sensor while placing the batteries closer to the sensor. Moving the batteries around a hand held compass also gives a good indication on whether the batteries are low magnetic or not. Batteries can also be degaussed to reduce the magnetic influence from the batteries.

9.3 Checking the tilt sensor

The sensor has a 3-axis inclinometer. The tilt is converted to rotational angles pitch and roll. When the sensor is placed horizontal the pitch and roll should be close to zero. Pitch is the rotation around the y-axis while roll is the rotation angle around the x-axis. The x-axis is aligned with transducer 1 and 3 and the y-axis is aligned with transducer 2 and 4.

- Place the sensor horizontal. See that the pitch and roll is close to zero.
- Tilt sensor towards transducer 1 (transducer 1 downwards) and see that the pitch value is decreasing (more negative).
- Tilt the sensor in the opposite direction against transducer 3 and see that the pitch is increasing (positive).
- Tilt the sensor towards transducer 2 and see that the roll value is increasing (positive).
- Tilt the sensor towards transducer 4 and see that the roll value is decreasing (more negative).
- Hold the sensor upside-down and horizontal. The roll should now be close to 180 degrees.
- Place the sensor upside-down on a table on transducer 1. The pitch should be close to -25 degrees and the roll close to 180.
- Do the same now on transducer 3. The pitch should now be close to +25 degrees and the roll close to 180.
- Do the same now on transducer 2. The roll should be close to 155 degrees while the pitch should be close to 0.
- Do the same on transducer 4. The roll should be close to 205 degrees and the pitch close to 0. For software version 8.2.1 and over, the roll range is ± 180 so the roll reading should be close to -155.

NOTE: To check the value measured by the tilt and heading sensor refer to chapter 4.2. Viewing incoming data in real-time.

9.4 Checking the acoustics

The best way to check the acoustics is to do a short pre-deployment where the sensor is hanging from a floating raft or boat. Checking the signal strength from the different beams gives an indication on if some of the beams are much weaker than the others. When checking the beam strengths close to the sensor, the signal strength should normally be within 2-3dB between the different beams.

A weaker signal strength on all transducers than seen earlier is not necessarily an indication that something is wrong with the sensor. The signal strength can show big variations during a year due to changes in biological activities, etc. Some places variations of the backscatter conditions can give several dB in signal strength variation.

CHAPTER 10 Maintenance

With 50 years of instruments design and production for the scientific community, in use around the world, you can count on our reputation for designing the most reliable products available.

We are guided by three underlying principles: quality, service, and commitment. We take these principles seriously, as they form the foundation upon which we provide lasting value to our customers. Our unmatched quality is based on a relentless program of continuous monitoring to maintain the highest standards of reliability.

In order to assure the quality of this sensor, critical properties are tested during production. A special form, named 'Test and Specification Sheet' (delivered with the sensor) lists the tests and their results and checkpoints.

10.1 Retrieval of the sensor

Clean the Transducer Head after each deployment.

Note!

Do not use any form of steel brush or any sharp objects on the Transducer Head, as this will damage the acoustic elements.

The sensor housing will tolerate most cleaning agents. Often 30% Hydrochloric acid (HCL) (Muriatic acid) or acetic acid will be useful for removing barnacles and similar fouling.

Be sure to follow the safety precaution for such acids.

10.2 Anti-fouling on transducer surface

The front layer on the transducers is optimized to give optimal matching between the transducers and the sea water to get as high sensitivity as possible. Applying anti-fouling to the surface may give reduced sensitivity. The best way to keep the fouling away would have been to wash the surface at a regular interval, for example once a week or dependent on how fast the growth is. This is however not very practical.

If applying anti-fouling, use a very thin and evenly layer on the transducer surfaces. The best is to use a coating which can be sprayed on as very thin layer.

10.3 Factory service

Factory service is offered for maintenance, repair or calibration.

When returning Doppler Current Profiler Sensor, always include the Instrument Service Order, Form No. 135; see our web pages under 'Support and Training'.

Normal servicing time is four to six weeks, but in special cases the service time can be reduced.

A main overhaul and service is recommended at the factory every three years

10.4 Example of Test & Specifications sheet and Certificates

AANDERAA TEST & SPECIFICATIONS

a xylem brand

Form No. 572, Oct 2014

Product: DCPS 5400

Serial No: 355

Digital Board

1. Tested according to Test Procedure DID-50855.

Analog Board x2

2. Tested according to Test Procedure DID-50856.

Complete Sensor

3. Tested according to Test Procedure DID-50858.

Performance test and results from Test Procedure DID-50858

4. Visual Check

- 4.1. Inspection of o-ring groove.
- 4.2. Pressure tested.
- 4.3. Electrical isolation to flange after pressure test.
- 4.4. Communication tested (AiCaP, Rs-232/Rs-422).

5. Current Consumption

- | | |
|---|----------------|
| 5.1. Quiescent, no ping (maximum 350 μ A) | 226.00 μ A |
| 5.2. Total with one ping each second (20 - 40 mA) | 30.60mA |

6. Compass and Tilt sensor

- 6.1. Compass and tilt calibrated.

7. Performance test

- 7.1. Climatic tests to control sensor performance over the whole temperature range.
- 7.2. Field test in sea water.

Date: 08 Feb 2019

Sign:

Halvard Skurve
Halvard Skurve, Production Engineer

Figure 10-1 Example of Test and Specification sheet



CALIBRATION CERTIFICATE

Form No 859, May 2019

Certificate no: 5400_260_00157905

Product: 5400
Calibration date: 16.05.2019

Serial no: 260
Page 1 of 2

This is to certify that this product has been calibrated and verified using the following reference equipment:

Reference Equipment Description	Serial
Compass HMR3500	13987
Encoder Sendix F3653	1412501654
Encoder Sendix F3653	1412501655
Encoder Sendix F3653	1412501653

Obtained Heading deviation for this product:

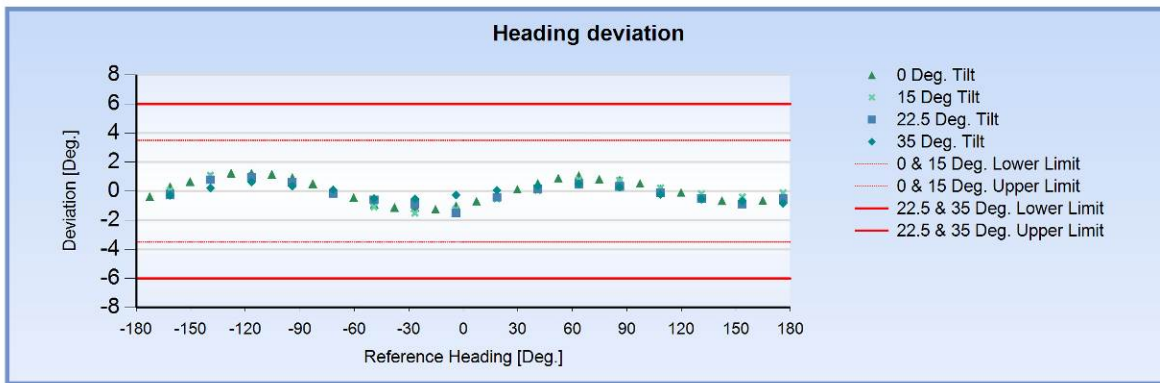

Obtained Pitch and Roll deviation for this product:

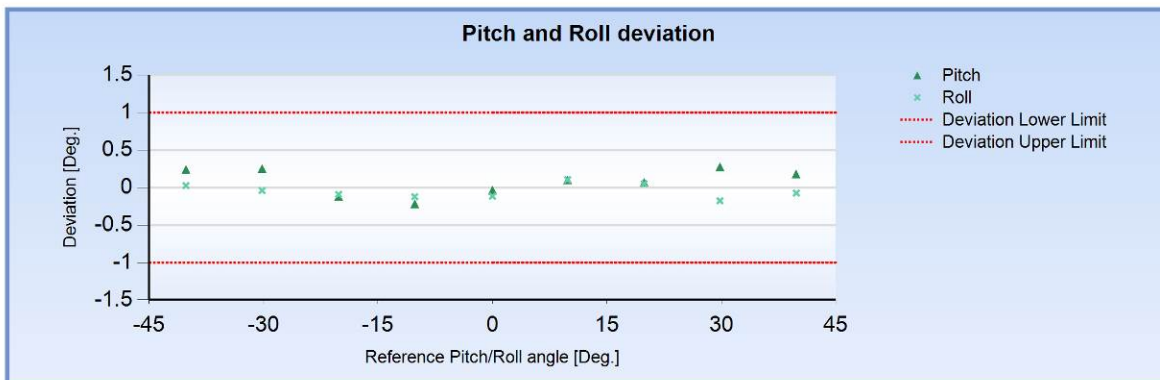

Figure 10-2: Example of Calibration Certificate compass and tilt page 1





CALIBRATION CERTIFICATE

Form No 859, May 2019

Certificate no: 5400_260_00157905

Product: 5400
Calibration date: 16.05.2019

Serial no: 260
Page 2 of 2

Using these Calibration Coefficients:

Index	0	1	2	3	4	5	6
Compass Coeffs Up	5.31572E02	-4.95104E01	5.48922E02	-1.02951E02	5.12860E02	1.91816E02	2.16892E00
Compass Coeffs Down	5.28409E02	-6.09271E01	5.50807E02	-1.06035E02	4.95228E02	2.17118E02	-1.89488E00
TiltX Coeffs Up	2.47264E-01	7.44686E-01					
TiltX Coeffs Down	2.53497E-01	7.48688E-01					
TiltY Coeffs Up	2.49805E-01	7.55326E-01					
TiltY Coeffs Down	2.51582E-01	7.53572E-01					

Date: 16.05.2019

Helge Soltveit, Production Engineer

Page 2

Figure 10-3: Example of Calibration Certificate compass and tilt page 2



AANDERAA CALIBRATION CERTIFICATE
 a xylem brand

Form No. 726, June 2007

Product: DCPS 5400

Serial No: 13

Calibration Date: 27 Jun 2014

This is to certify that this product has been calibrated using the following instruments:

Calibration Bath model FNT 321-1-40
 ASL Digital Thermometer model F250 Serial: 6792/06

Calibration points and readings:

Parameter: Temperature

Calibration points and readings

Temperature (°C)	1.116	11.984	24.011	35.845	0.000	0.000
Reading (LSB)	12460344	10790645	8813782	6949004	0	0

Giving these coefficients

Index	0	1	2	3	4	5
TempCoef	2.66185E01	-5.17975E01	8.06210E00	-1.97612E01	0.00000E00	0.00000E00

Date: 27 Jun 2014

Sign:



Tor-Ove Kvalvaag, Calibration Engineer

Aanderaa Data Instruments AS

Sanddalsringen 5b, Postboks 103 Midtun, 5828 Bergen
 Tel +47 55 60 48 00 Fax +47 55 60 48 01

aanderaa.info@xyleminc.com

www.aanderaa.com

Figure 10-4 Example of Calibration Certificate for optional Temperature Sensor



PRESSURE CERTIFICATE

Form No. 667, Sept 2009

Product: DCS 4830R
Serial No: Demo
Date: 02.05.2013

Certificate No: 83053255101

This is to certify that this product has been pressure tested with the following instrument, and we confirm that no irregularities were found during the test:

Autoklav 800 bar – sn: 0210005

Pressure readings:

Pressure (Bar)	Pressure time (hour)
30	1

Date: 02 May 2013

Sign:

Ragnhild Eide Ure, Production Engineer

AANDERAA DATA INSTRUMENTS AS

5851 BERGEN, NORWAY

Tel. +47 55 60 48 00

Fax. +47 55 60 48 01

E-mail: info@aadi.no

Web: <http://www.aadi.no>

Figure 10-5 Example of Pressure Certificate



CHAPTER 11 Installation

11.1 AADI Real-Time Collector connection with Windows 10

Windows 10 USB to SeaGuard / SmartGuard fixes

Download Windows mobile device center (WMDC) 32 or 64 bit version:

<https://support.microsoft.com/en-us/help/931937/description-of-windows-mobile-device-center>



Windows 10 ver. 1703 / 1709

Problem: WMDC (Windows mobile device center) hangs at splash screen

Log on with local administrator privileges

In the search field enter: services

Scroll down to “Windows Mobile-2003-based device connectivity”

 Windows Mobile-2003-based device connectivity	Provides connectivity for Windows Mobile-2003-based devices	Running	Automatic	Local Service
 Windows Mobile-based device connectivity	Provides remote command and control to Windows Mobile-based devices.	Running	Automatic	Local Service

Right click and click on properties on the Windows Mobile-2003-based device connectivity

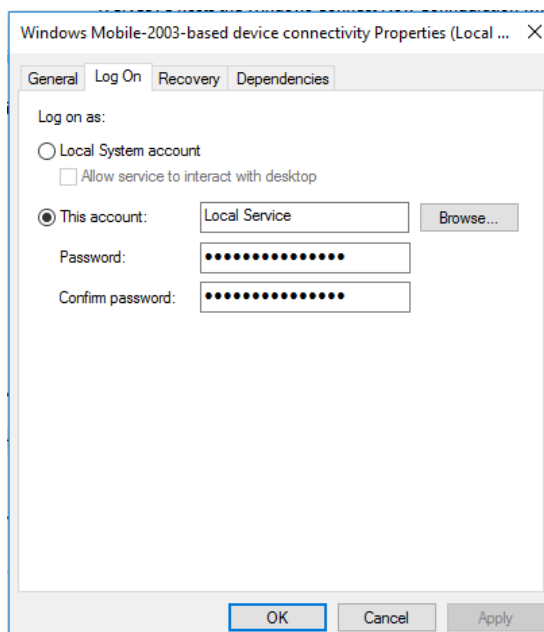

Click on Local System account.

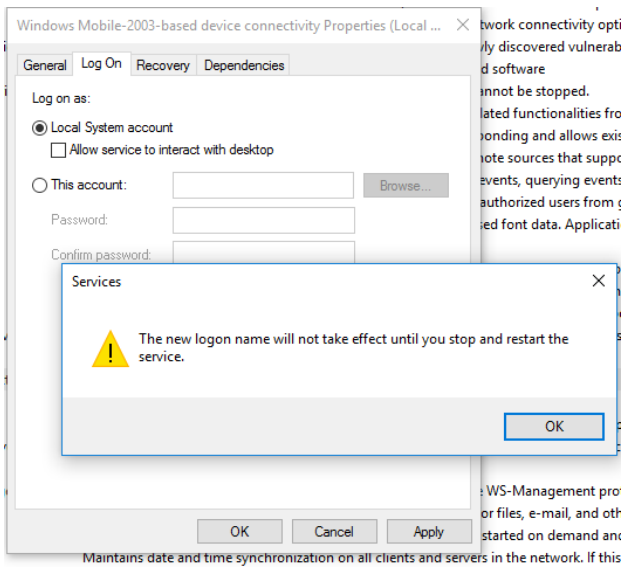

Click ok and ok.

Do the same with Windows Mobile-based device connectivity.



Restart pc and plug in the USB cable from SmartGuard / SeaGuard.

11.2 Connecting Cables

Aanderaa offers a wide range of standard cables;

11.2.1 For AiCaP and RS-232 use

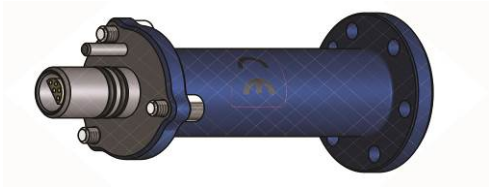
Table 11-1: Available cables for AiCaP and RS-232

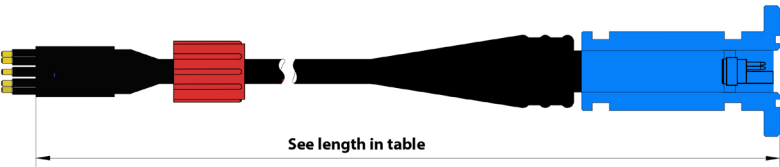
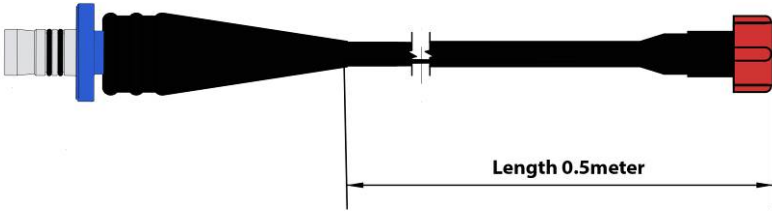
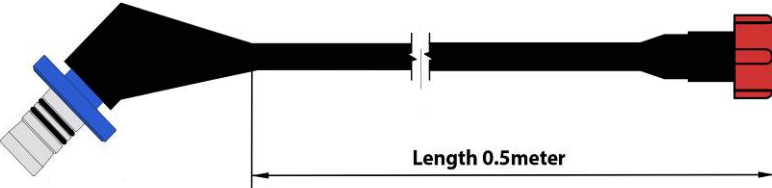
	<ul style="list-style-type: none"> • 4318 Sensor Foot AiCaP • Used to connect DCPS to SeaGuardII top-end plate • Only for use in center hole
	<ul style="list-style-type: none"> • 4838 Sensor Cable AiCaP • Used for remote connection of DCPS, between sensor and SeaGuardII top-end plate • Only for use in center hole
 <p>See length in table</p>	<ul style="list-style-type: none"> • 5340 Sensor Cable AiCaP and RS-232 • Used for remote connection of DCPS, between sensor and top-end plate via male 8pin Subconn • Needs 5662 or 4872 for connection to SeaGuard top-end plate or 5245 for connection to SmartGuard
 <p>Length 0.5meter</p>	<ul style="list-style-type: none"> • 5662 Connection Cable AiCaP • Connection between straight plug on SeaGuardII top-end plate using sensor hole and 8pin Subconn on 5340 cable • Needs 5340 cable for connection
 <p>Length 0.5meter</p>	<ul style="list-style-type: none"> • 4872 Connection Cable AiCaP • Connection between angular plug on SeaGuardII top-end plate using sensor hole and 8pin Subconn on 5340 cable • Needs 5340 cable for connection

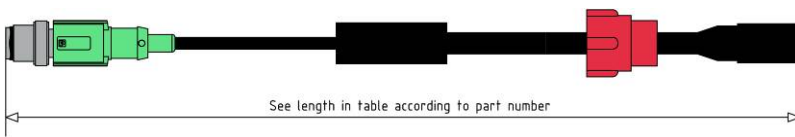
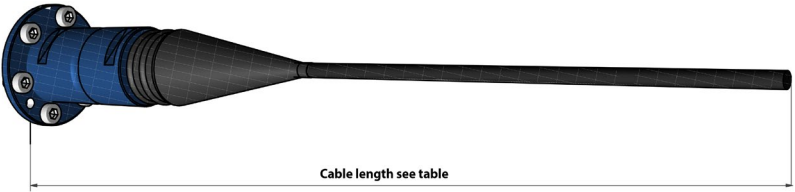
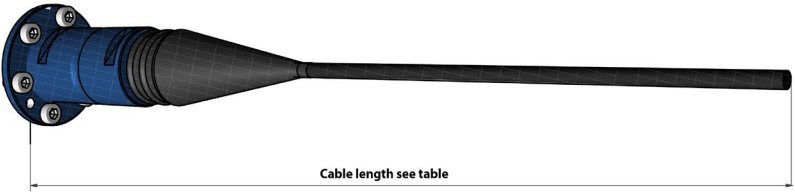
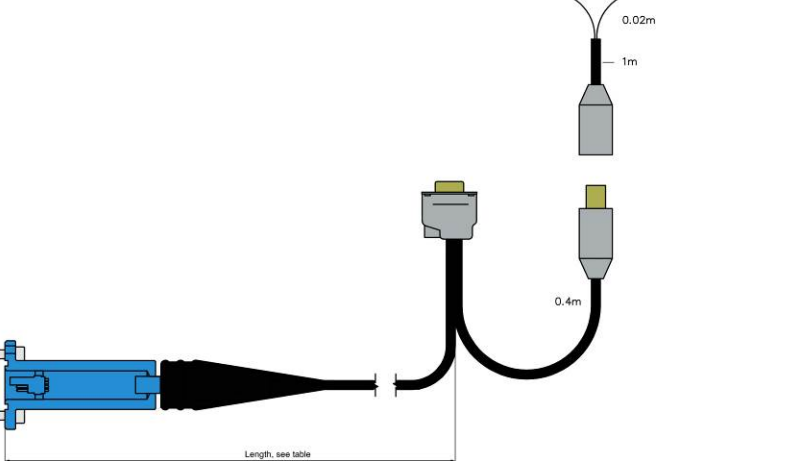
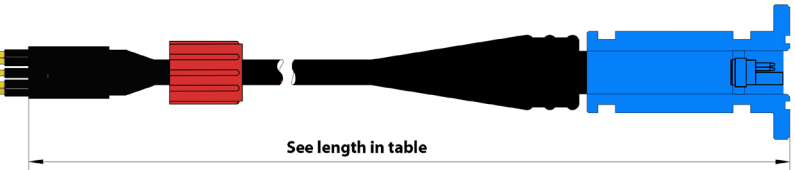

 <p>See length in table according to part number</p>	<ul style="list-style-type: none"> • 5245 Connection Cable AiCaP • Connection between SmartGuard M12 plug and 8pin Subconn on 5340 cable • Needs 5340 cable for connection
 <p>Cable length see table</p>	<ul style="list-style-type: none"> • 5414 Sensor Cable AiCaP • Free end cable for connection between sensor and Aanderaa logger
 <p>Cable length see table</p>	<ul style="list-style-type: none"> • 4860 Sensor Cable RS-232 • Free end cable for connection between sensor and 3rd party logger
 <p>Length, see table</p>	<ul style="list-style-type: none"> • 4834 Sensor Cable • Sensor cable with 9pin Dsub for connection between DCPS and PC
 <p>See length in table</p>	<ul style="list-style-type: none"> • 5159 Sensor Cable RS-232 • RS-232 • To be used with Real-Time cable

	<ul style="list-style-type: none"> • 3855 Set-up and configuration cable • Non watertight Set-up cable with 9pin DsuB for connection between 10pin Lemo and PC for laboratory use only
--	--

11.2.2 For RS-422 use

Table 11-2: Available cables for RS-422

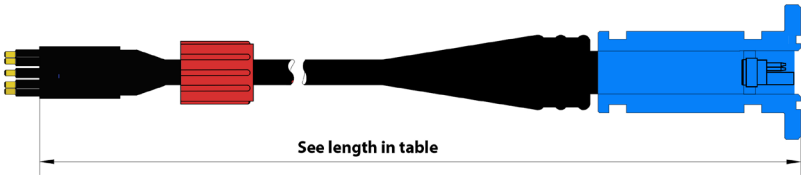
	<ul style="list-style-type: none"> • 4860 Sensor Cable RS-422 • Free end cable for connection between sensor and 3rd party logger
	<ul style="list-style-type: none"> • 4902 Sensor Cable • Sensor cable with 9pin DsuB for connection between DCPS and PC • RS-422/RS-232 converter included

 <p>See length in table</p>	<ul style="list-style-type: none"> • 5159 Sensor Cable RS-422 • To be used with Real-Time cable
 <p>Positive Supply Negative Supply</p>	<ul style="list-style-type: none"> • 5618 Set-up and configuration cable • Non watertight Set-up cable with 9pin Dsub for connection between 10pin Lemo and PC for laboratory use only • RS-422/RS-232 converter included

11.3 Mounting considerations

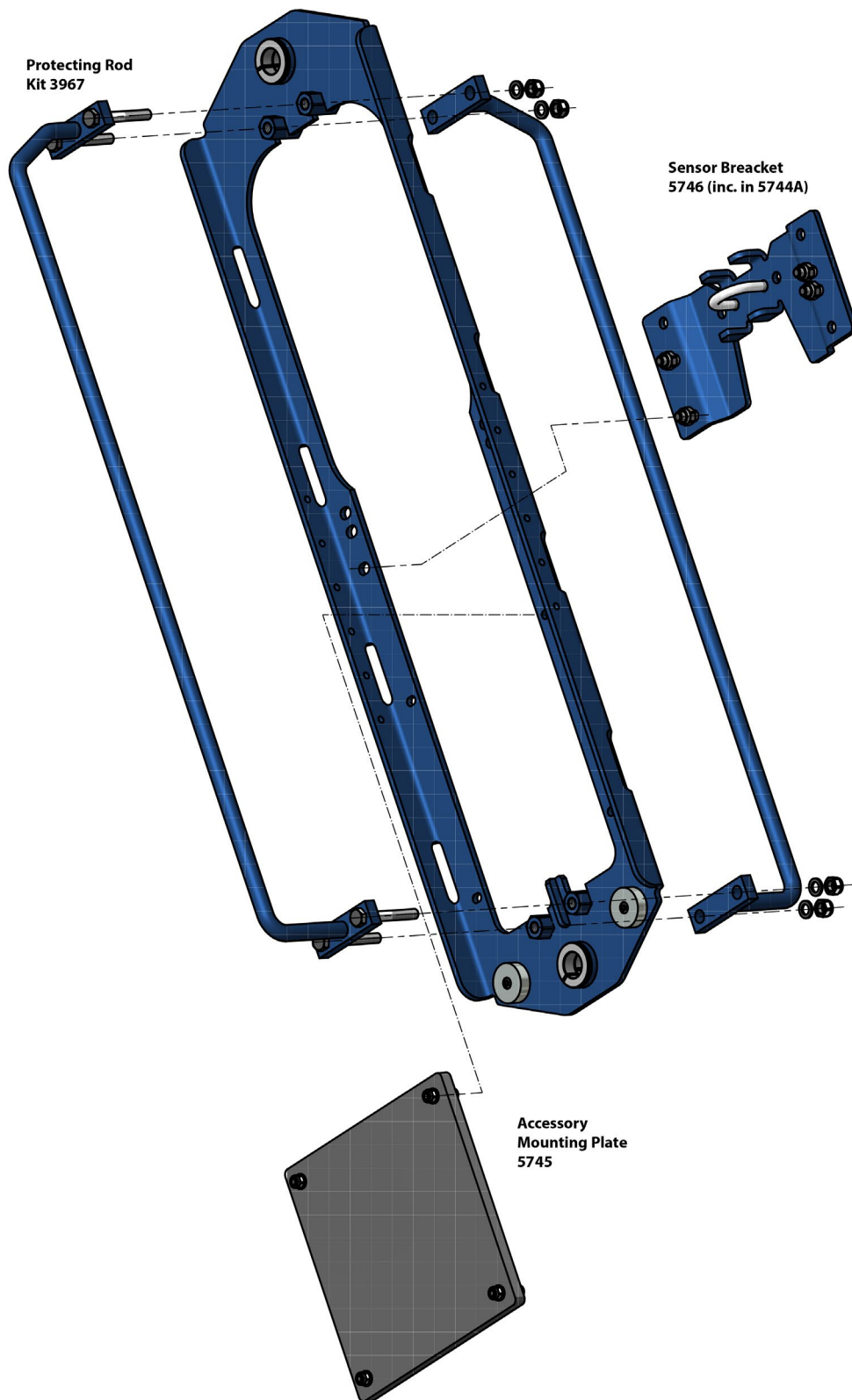

Figure 11-1: Inline mooring frame 5744A

11.4 Application examples

DCPS is a flexible sensor that can be used in many different applications, either as a part of a SeaGuard II self-contained multiparameter observatory or as a part of a flexible user designed observation point. The factory also helps users with designing system to solve a specific task. The next examples are just two of many hundreds system already delivered.

First example in **Figure 11-2** shows a small system designed for a fish farm measuring Current in multiple layers, Salinity at one depth and Oxygen at four depths. This system is easily scalable to fit the individual needs

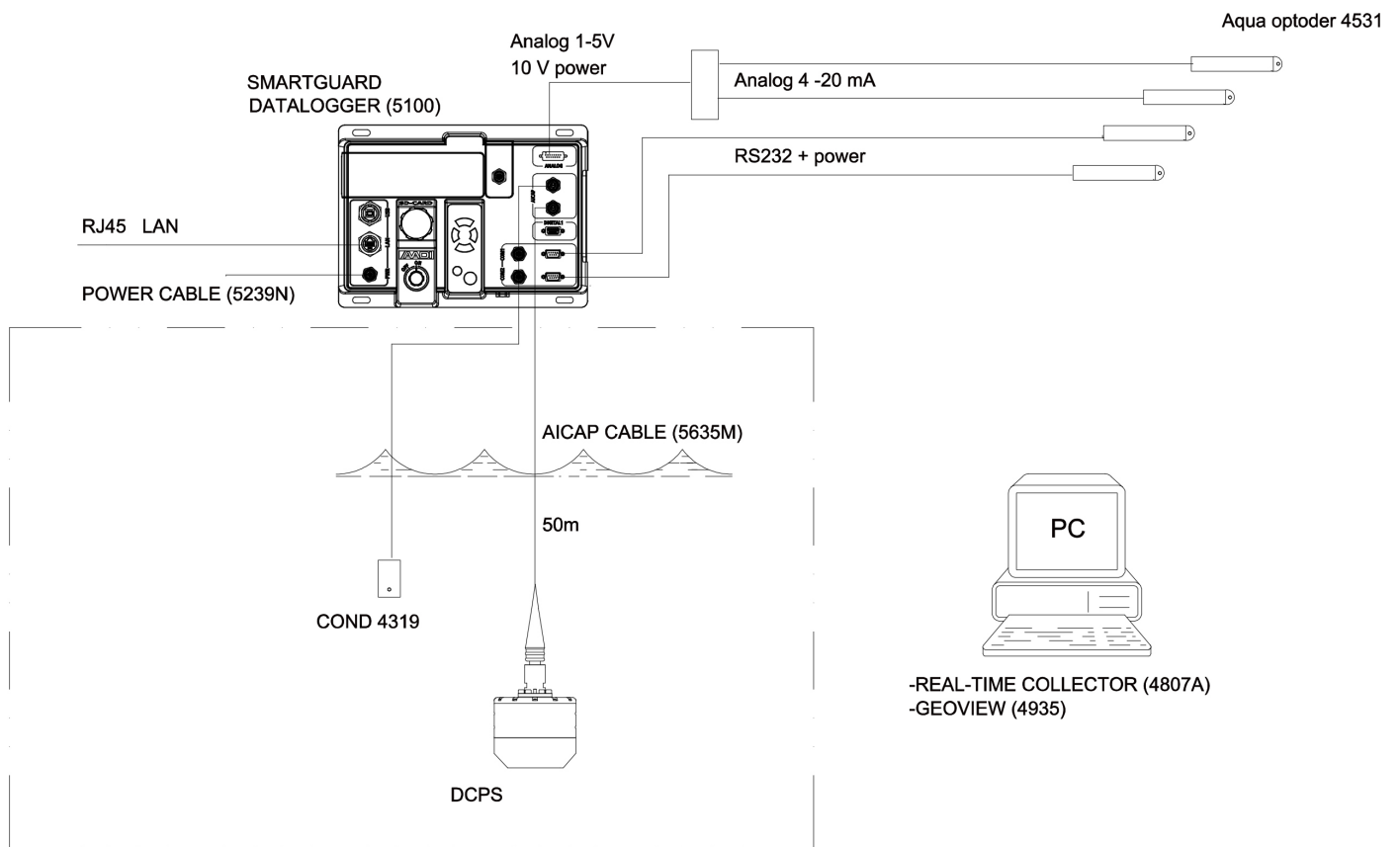

Figure 11-2: Example 1

Example 2 in **Figure 11-3** shows a more complex buoy system with meteorological sensors, satellite communication, solar panels as well as Motus directional wave sensor and DCPS. This system is also easily scalable with possibilities for adding water quality sensors and single-point current measurement for measuring current close to the surface.

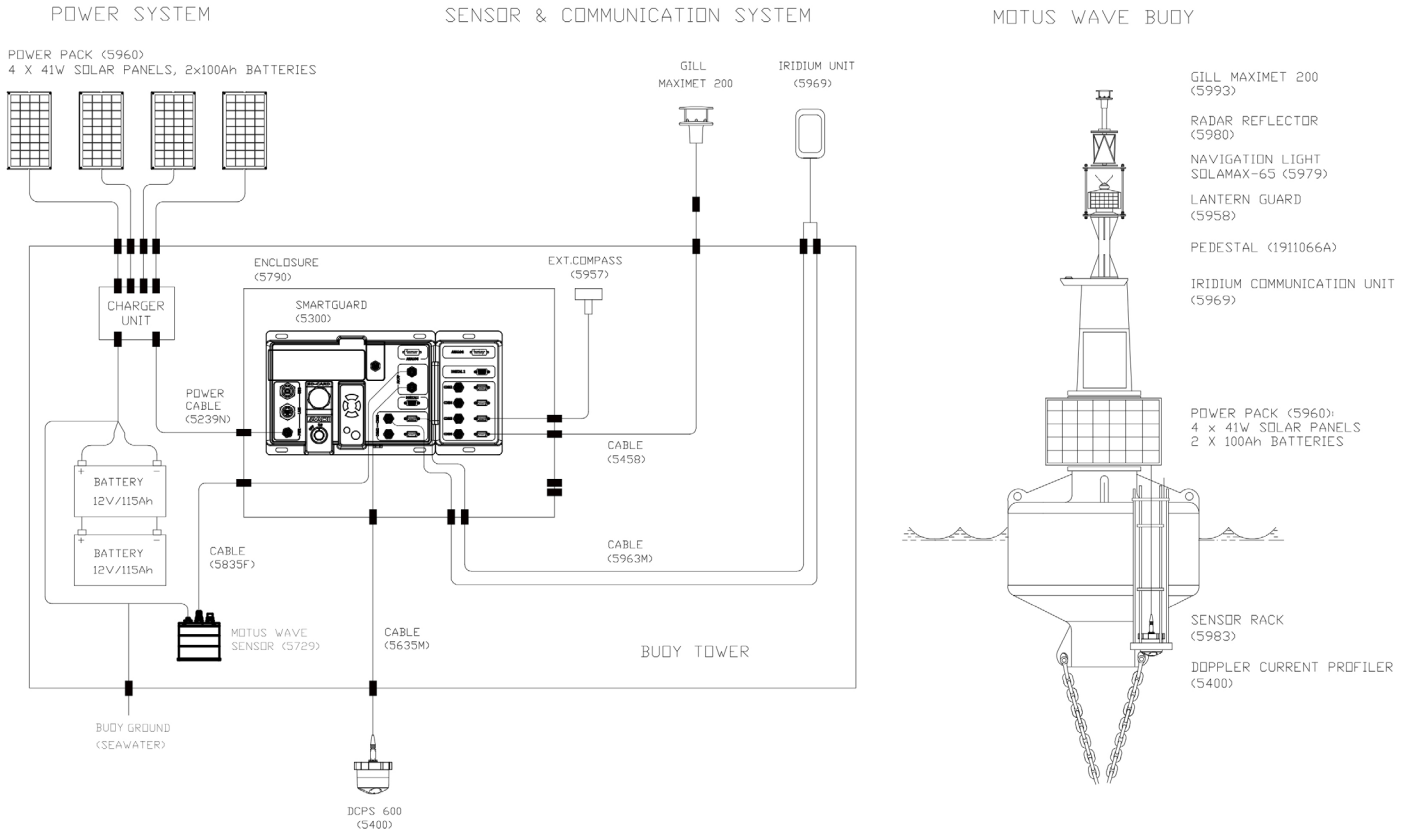

Figure 11-3: Example 2

Aanderaa Data Instruments AS

P.O.Box 103 Midtun, Sanddalsringen 5b, N-5843 Bergen, Norway

Tel: +47 55 60 48 00 Fax: +47 55 60 48 01

email: aanderaa.info@xylem.com - www.aanderaa.com

Aanderaa Data Instruments AS is a trademark of Xylem Inc. or one of its subsidiaries.

© 2019 Xylem, Inc. July 2019

xylem
Let's Solve Water

